



# PROMODAY 2026

ITALIA € IVA ESCLUSA





<b>02</b>	<b>—</b>	<b>CHIAVI DI MANOVRA</b>
<b>06</b>	<b>—</b>	<b>CHIAVI A BUSSOLA</b>
<b>12</b>	<b>—</b>	<b>GIRAVITI E PINZE</b>
<b>16</b>	<b>—</b>	<b>ELETTRONICA ED ELETTROTECNICA</b>
<b>18</b>	<b>—</b>	<b>UTENSILI DINAMOMETRICI</b>
<b>20</b>	<b>—</b>	<b>UTENSILI DA TAGLIO</b>
<b>22</b>	<b>—</b>	<b>MANUTENZIONE GENERALE</b>
<b>28</b>	<b>—</b>	<b>ILLUMINAZIONE</b>
<b>36</b>	<b>—</b>	<b>POWER TOOLS</b>
<b>42</b>	<b>—</b>	<b>ESTRATTORI</b>
<b>44</b>	<b>—</b>	<b>UTENSILI PNEUMATICI</b>
<b>52</b>	<b>—</b>	<b>CARRELLI E BANCHI DA LAVORO</b>
<b>92</b>	<b>—</b>	<b>ARREDAMENTO TECNICO</b>
<b>106</b>	<b>—</b>	<b>ARREDAMENTO FURGONI</b>
<b>110</b>	<b>—</b>	<b>AUTOMOTIVE</b>
<b>132</b>	<b>—</b>	<b>PROFESSIONAL EQUIPMENT</b>



## CHIAVI DI MANOVRA



### INDUSTRIAL

#### FG 600/A

**DESIGN DELLA TESTA OTTIMIZZATO**  
Per garantire un'elevata forza torcente

**ELEVATE PRESTAZIONI**  
Raggiunge valori di coppia superiori del doppio rispetto agli standard

**TESTA POLIGONALE DISASSATA**  
Inclinata di 15° per accedere a dadi e bulloni incassati rispetto alla superficie di lavoro e per proteggere la mano dell'utilizzatore

### CHIAVE COMBINATA



15°

#### FG 600A/SC16

€/LISTINO  
~~245,00~~

PROMO  
**149,00€**

SET CHIAVI COMBINATE POLIGONALI - SERIE INDUSTRIAL  
Contenuto: 6, 7, 8, 10, 12, 13, 14, 16, 17, 19, 21, 22, 24, 27, 30, 32mm

#### FG 600A/SC25

€/LISTINO  
~~405,00~~

PROMO  
**229,00€**

SET CHIAVI COMBINATE POLIGONALI - SERIE INDUSTRIAL  
Contenuto: 6, 7, 8, 9, 10, 11, 12, 13, 14, 15, 16, 17, 18, 19, 20, 21, 22, 23, 24, 25, 26, 27, 28, 30, 32mm



#### FG 600/SC16

€/LISTINO  
~~232,00~~

PROMO  
**139,00€**

SET CHIAVI COMBINATE POLIGONALI  
Contenuto: 6, 7, 8, 10, 12, 13, 14, 16, 17, 19, 21, 22, 24, 27, 30, 32mm

#### FG 600/SC25

€/LISTINO  
~~385,00~~

PROMO  
**219,00€**

SET CHIAVI COMBINATE POLIGONALI  
Contenuto: 6, 7, 8, 9, 10, 11, 12, 13, 14, 15, 16, 17, 18, 19, 20, 21, 22, 23, 24, 25, 26, 27, 28, 30, 32mm



#### FG 600L/SC10

€/LISTINO  
~~162,00~~

PROMO  
**99,00€**

SET CHIAVI COMBINATE POLIGONALI EXTRA LUNGHE  
Contenuto: 10, 11, 12, 13, 14, 15, 16, 17, 18, 19mm



**CHIAVE  
COMBINATA  
TWISTER**

La chiave **TWISTER** Fasano Tools ha un design unico e innovativo: la rotazione sul manico fa sì che la forchetta e la testa poligonale siano perpendicolari tra loro, affinché l'utilizzatore impugni la chiave dal lato piatto avendo a disposizione una superficie maggiore di appoggio.

Questo consente di aumentare la forza torcente di più del **30%** rispetto alle chiavi standard, riducendo notevolmente lo sforzo e l'affaticamento della mano durante l'uso.



**FG 600/TW**

**MAGGIORE  
FORZA  
TORCENTE**

**FG 600TW/S12**

€/LISTINO  
~~198,00~~

**PROMO  
119,00€**

**SET CHIAVI COMBINATE TWISTER**

Contenuto: 8, 9, 10, 11, 12, 13, 14, 15, 16, 17, 18, 19mm



**FG 600XL/SC7**

€/LISTINO  
~~210,00~~

**PROMO  
129,00€**

**SET CHIAVI POLIGONALI DOPPIE EXTRA LUNGHE**

Contenuto: 8x10, 12x14, 13x15, 16x18, 17x19, 21x23, 22x24mm



**FG 615/SC8**

€/LISTINO  
~~116,00~~

**PROMO  
69,00€**

**SET CHIAVI POLIGONALI DOPPIE CURVE**

Contenuto: 6x7, 8x9, 10x11, 12x13, 14x15, 16x17, 18x19, 20x22mm



**FG 602/SC13**

€/LISTINO  
~~150,00~~

**PROMO  
89,00€**

**SET CHIAVI A DOPPIA FORCHETTA**

Contenuto: 6x7, 8x9, 10x11, 12x13, 14x15, 16x17, 18x19, 20x22, 21x23, 24x26, 25x28, 27x29, 30x32mm



**FG 180/SP9**

€/LISTINO  
~~216,00~~

**PROMO  
129,00€**

**SET CHIAVI PER RACCORDI TUBO**

Contenuto: 8x10, 10x11, 11x13, 12x14, 17x19, 19x22, 24x27, 30x32mm



**FG 600E/S4**

€/LISTINO  
~~56,00~~

**PROMO  
33,90€**

**SET 4 CHIAVI DOPPIE DIRITTE TORX**

Contenuto: E6xE8, E10xE12, E14xE18, E20xE24





## FG 623H/S6

€/LISTINO  
~~120,00~~

PROMO  
**72,00€**

SET CHIAVI A T MASCHIO ESAGONALI AD ASTA FISSA

Contenuto: 2,5, 3, 4, 5, 6, 8mm

## FG 623H/S8

€/LISTINO  
~~175,00~~

PROMO  
**105,00€**

SET CHIAVI A T MASCHIO ESAGONALI AD ASTA FISSA

Contenuto: 2, 2,5, 3, 4, 5, 6, 8, 10mm

## FG 623H/S14

€/LISTINO  
~~345,00~~

PROMO  
**209,00€**

SET CHIAVI A T MASCHIO ESAGONALI AD ASTA FISSA

Contenuto: 2, 2,5, 3, 3,5, 4, 4,5, 5, 6, 7, 8, 9, 10, 12, 14mm



## INDUSTRIAL

## CHIAVE A T MASCHIO AD ASTA FISSA

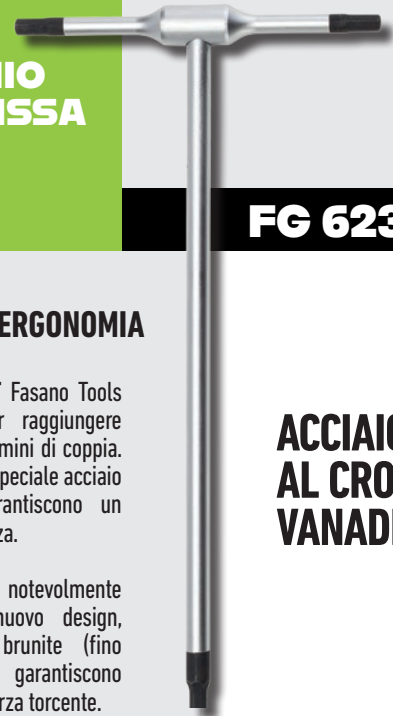

## FG 623/H

### PRESTAZIONI ED ERGONOMIA

La **Chiave maschio a T** Fasano Tools è stata progettata per raggiungere prestazioni elevate in termini di coppia. L'impugnatura fissa e lo speciale acciaio al Cromo Vanadio garantiscono un elevato livello di resistenza.

L'ergonomia è stata notevolmente migliorata grazie al nuovo design, mentre le estremità brunate (fino alla misura da 8 mm) garantiscono un'elevata resistenza e forza torcente.

## ACCIAIO AL CROMO VANADIO

## FG 621H/S8C

€/LISTINO  
~~162,00~~

PROMO  
**99,00€**

SET CHIAVI A T MASCHIO ESAGONALI AD ASTA SCORREVOLE

Contenuto: 2, 2,5, 3, 4, 5, 6, 8, 10mm



## FG 618/S7B

€/LISTINO  
~~265,00~~

PROMO  
**159,00€**

SET CHIAVI A T SNODATE ESAGONALI

Contenuto: 7, 8, 10, 12, 13, 14, 17mm

## FG 618/S7

€/LISTINO  
~~293,00~~

PROMO  
**175,00€**

SET CHIAVI A T SNODATE ESAGONALI

Contenuto: 8, 10, 11, 13, 14, 17, 19mm

## FG 618/S10

€/LISTINO  
~~418,00~~

PROMO  
**249,00€**

SET CHIAVI A T SNODATE ESAGONALI

Contenuto: 8, 10, 11, 12, 13, 14, 15, 16, 17, 19mm

## FG 621TX/S13

€/LISTINO  
~~250,00~~

PROMO  
**149,00€**

SET CHIAVI A T MASCHIO TORX CON ASTA SCORREVOLE

Contenuto: 6, 7, 8, 9, 10, 15, 20, 25, 27, 30, 40, 45, 50 TX

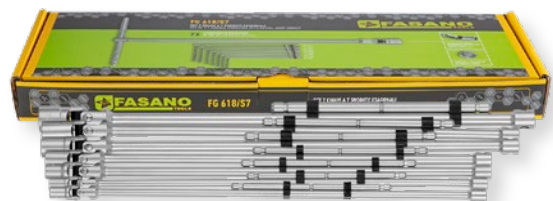

**GIRATUBI MODELLO AMERICANO**



CODICE	Ø GAS MAX	Ø MM MAX	L/MM	€/LISTINO	€/PROMO
FG 30/GA1.5	1"1/2	33	250	40,00	24,00
FG 30/GA2	2"	42	300	48,00	29,00
FG 30/GA2B	2"	48	350	56,00	34,00
FG 30/GA2.5	2"1/2	60	450	82,00	49,00
FG 30/GA3	3"	73	600	125,00	75,00
FG 30/GA5	5"	102	900	150,00	90,00
FG 30/GA6	6"	141	1200	240,00	145,00

**GIRATUBI MODELLO SVEDESE CON GANASCE PARALLELE A 45°**



CODICE	Ø GAS MAX	Ø MM MAX	L/MM	€/LISTINO	€/PROMO
FG 32/GP1	1"	41	300	32,00	19,00
FG 32/GP1.5	1"1/2	56	420	45,00	27,00
FG 32/GP2	2"	68	530	70,00	42,00

**FG 605/ST11-B**

€/LISTINO  
~~238,00~~

**PROMO**  
**139,00€**

**SET CHIAVI A CRICCO REVERSIBILI**

Contenuto: 8, 9, 10, 11, 12, 13, 14, 15, 16, 17, 19mm



ANELLO IN ACCIAIO INTEGRATO CHE CONSENTE LA TENUTA DEL BULLONE

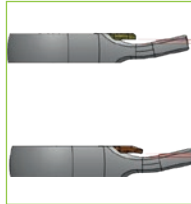

LEVA DI INVERSIONE A FILO TESTA E CON LINGUETTA INCLINATA VERSO IL BASSO PER UN MAGGIORE SPAZIO DI MANOVRA

**GIRATUBI MODELLO AMERICANO IN ALLUMINIO**



CODICE	Ø GAS MAX	Ø MM MAX	L/MM	€/LISTINO	€/PROMO
FG 33/GA2	2"	48	350	60,00	36,00
FG 33/GA2.5	2"1/2	60	450	80,00	49,00
FG 33/GA3	3"	73	600	140,00	85,00
FG 33/GA5	5"	102	900	260,00	155,00
FG 33/GA6	6"	141	1200	310,00	189,00

**GIRATUBI MODELLO LEGGERO**



CODICE	Ø GAS MAX	Ø MM MAX	L/MM	€/LISTINO	€/PROMO
FG 34/GL1	1"	38	175	25,00	14,90
FG 34/GL1.5	1"1/2	50	225	30,00	18,00
FG 34/GL2	2"	57	260	35,00	21,00
FG 34/GL2.5	2"1/2	70	300	40,00	24,00
FG 34/GL3	3"	90	325	45,00	27,00

**FG 606/SP9**

€/LISTINO  
~~140,00~~

**PROMO**  
**85,00€**

**SET CHIAVI COMBINATE A CRICCO NON REVERSIBILI**

Contenuto: 8, 10, 11, 12, 13, 14, 15, 17, 19mm



**FG 610FL/SP9**

€/LISTINO  
~~252,00~~

**PROMO**  
**149,00€**

**SET CHIAVI COMBINATE A CRICCO FLESSIBILI**

Contenuto: 8, 10, 12, 13, 15, 16, 17, 18, 19mm



**FG 622A/S2**

€/LISTINO  
~~80,00~~

**PROMO**  
**49,00€**

**SET 2 CHIAVI A CRICCO UNIVERSALE SERIE EXTRA-LUNGA**

Contenuto: 21x22, 24x27 mm



**FG 615A/S6**

€/LISTINO  
~~130,00~~

**PROMO**  
**79,00€**

**SET 6 CHIAVI DOPPIE CON CRICCO REVERSIBILE UNIVERSALE A 90 DENTI**

Contenuto: 8x9, 10x11, 12x13, 14x15, 16x18, 17x19mm





## CHIAVI A BUSSOLA



23 mm  
DI INGOMBRO  
TOTALE

**NEW**

### FG 625/S15

€/LISTINO

~~98,00~~

**PROMO**  
**59,00€**

#### SET BUSSOLE E ACCESSORI

Con chiavi a bussola piatte e cricchetto

Fornito in box di ABS con modulo in gomma morbida

3/8"

#### CONTENUTO



L/mm 190



L/mm 75 - 3/8"



3/8"



8- 9- 10- 11- 12- 13- 14- 15- 16- 17- 18-19mm



BUSSOLE PIATTE

#### — QUALITÀ E PRATICITÀ D'USO

- Cricchetto con meccanismo a 72 denti ed impugnatura antiscivolo
- Inversione del senso di rotazione con una sola mano grazie all'apposita leva e meccanismo di aggancio/sgancio rapido degli accessori con sistema a scatto

#### — MASSIMA ACCESSIBILITÀ

Consente di raggiungere con il minimo sforzo anche i punti di difficile accesso grazie all'adattatore e alla prolunga in dotazione

Design ultra sottile della testa del cricchetto: solo 11 mm di spessore



### FG 624/S25

€/LISTINO

~~98,00~~

**PROMO**  
**49,00€**

#### SET 25 UTENSILI - ATTACCO 1/4"

1/4"



#### CONTENUTO



FG 624/E

6,8,10,11,12,13mm



FG 624/CR14



FG 89/38PI1

1/4"x 1/4"



FG 85/25PH

1, 2, 3



FG 85/25PZ

1, 2, 3



FG 85/25F

4, 5, 6, 7



FG 85/25TX

10, 15, 20, 25, 27, 30, 40



**FG 625/S110**

€/LISTINO  
~~488,00~~

**PROMO**  
**259,00€**

SET 110 UTENSILI - ATTACCO 1/4" E 1/2"



**CONTENUTO**

- |  |              |   |
|--|--------------|---|
|  | FG 625/A     | 8,9,10,11,12,13,14,15,16,17,18,19,20,21,22,23,24,25,26,27,30,32 |
|  | FG 624/E     | 4,5,6,7,8,9,10,11,12,13,14                                      |
|  | FG 624/CR14  |   |
|  | FG 625/CR12  |   |
|  | FG 625/SN12  |   |
|  | FG 624/SN14  |   |
|  | FG 625/ES12  |   |
|  | FG 624/ES14  |   |
|  | FG 624/GR14C |   |
|  | FG 625/PA    | 125, 250  |
|  | FG 624/PA    | 50, 100   |
|  | FG 89/38P11  | 1/4"x1/4"   |
|  | FG 85/25PH   | 1,2,3   |
|  | FG 85/25SL   | 3,4,4.5,5,5.5,6,6.5   |
|  | FG 85/25PZ   | 1,2,3   |
|  | FG 85/H      | 1.5,2.2,5,3,4,5,6   |
|  | FG 85/25T    | 9,10,15,20,25,27,30,40  |
|  | FG 88/60P12  |   |

- |  |             |                           |
|--|-------------|---------------------------|
|  | FG 139/B    |                           |
|  | FG 48/L     |                           |
|  | FG 49       |                           |
|  | FG 600/B    | 8,10,11,12,13,14,15,17,19 |
|  | FG 22       | 3x75, 4x100, 5.5x100      |
|  | FG 22/PH    | 0x60, PH1x80, PH2x100     |
|  | FG 59/XT160 |                           |
|  | FG 63/XT160 |                           |
|  | FG 58/B240  |                           |
|  | FG 132/H500 |                           |
|  | FG 79/SP    |                           |
|  | FG 93/M24   |                           |
|  | FG 44/MT5   |                           |



**FG 625/S27**

€/LISTINO  
~~196,00~~

**PROMO**  
**99,00€**

SET 27 UTENSILI - ATTACCO 1/2"



**CONTENUTO**









- |  |             |   |
|--|-------------|---|
|  | FG 625/A    | 8,9,10,11,12,13,14,15,16,17,18,19,20,21,22,23,24,25,26,27,30,32 |
|  | FG 625/CR12 |   |
|  | FG 625/SN12 |   |
|  | FG 625/ES12 |   |
|  | FG 625/PA   | 125,250   |



# CHIAVI A BUSSOLA



## CONTENUTO

	FG 625/A	10,11,12,13,14,15,16,17,18,19,20,21,22,23,24,27,30,32
	FG 624/E	4,4.5,5.5,6,7,8,9,10,11,12,13,14
	FG 625L/A	14,15,17,19,22
	FG 624E/L	6,7,8,9,10,11,12,13
	FG 625/TX	10,11,12,14,16,18,20,24
	FG 624/TX	4,5,6,7,8
	FG 181/B	16,21
	FG 624/CR14 FG 625/CR12	









## FG BEST 108

€ LISTINO  
~~279,00~~

PROMO  
**139,00€**









SET 108 UTENSILI - ATTACCO 1/4"  
E 1/2"



	FG 625/SN12 FG 624/SN14	
	FG 625/ES12 FG 624/ES14	
	FG 624/GR14	
	FG 625/PR FG 624/PR	125 50,100
	FG 87/AD	
	FG 139/D	1,5,2,2,5
	FG 147/	PH (1,2), PZ (1,2), SL (4, 5.5, 6.5), H (4,5,5,6,5), TX (10,15,20,25,30)
	FG 85/	PH (3,4), PZ (3,4), SL (8,10,12), H (7,8,10,12,14), TX (40,45,50,55,60)



## CONTENUTO

	FG 625/A	10, 11, 12, 13, 14, 15, 16, 17, 18, 19, 20, 21, 22, 24, 27, 30, 32
	FG 624/E	4, 4.5, 5, 5.5, 6, 7, 8, 9, 10, 11, 12, 13, 14
	FG 624/B	10, 11, 12, 13, 14, 15, 16, 17, 18, 19
	FG 624/TX FG 624B/TX FG 625/TX	4, 5, 6, 7, 8, 10, 11, 12, 14, 16, 18, 20, 24
	FG 625L/A FG 624B/L FG 624E/L	16, 17, 18, 19, 22 10, 11, 12, 13, 14, 15 4, 5, 6, 7, 8, 9, 10
	FG 181/B FG 181/A	16, 21 18
	FG 87/AD FG 87/AD3	1/2"x5/16" 3/8"x5/16"
	FG 624/PR FG 624B/PR FG 625/PR	50, 100 125 125

## FG BEST 171

€ LISTINO  
~~409,00~~

PROMO  
**179,00€**

SET 171 UTENSILI - ATTACCO 1/4", 3/8" E 1/2"



	FG 625/CR12 FG 624/CR38 FG 624/CR14	
	FG 624/GR14	
	FG 625/SN12 FG 624/SN38 FG 624/SN14	
	FG 625/ES12-B FG 624/ES14	
	FG 139/D	1, 1.5, 2, 2.5, 3, 4, 5
	FG 147/	PH (0, 1, 2), PZ (0, 1, 2), SL (4, 5.5, 6.5, 7), H (3, 4, 5), TX (8, 9, 10, 15, 20, 25, 27, 30), RTX (8, 9, 10, 15, 20, 25, 27, 30)
	FG 87/25	PH (3, 4), PZ (3, 4), SL (8, 10, 12), H (7, 8, 10, 12, 14), TX (40, 45, 50, 55, 60, 70), RTX (40, 45, 50, 55, 60, 70)
	FG 85/25	M (5, 6, 8), T (5, 6, 7), TT7, RIBE (5, 6, 7, 8, 9), TS (10, 15, 20, 25, 27, 30, 40, 45)

**NEW**



**AMPIO ASSORTIMENTO,  
SEMPRE IN ORDINE E A PORTATA DI MANO**

**77**

**CHIAVI A BUSSOLA**

**6**

**DIVERSI PROFILI TORX NELLE MISURE PIÙ UTILIZZATE**

**3**

**DIVERSI ATTACCHI 1/4", 3/8", 1/2"**

**PER SVOLGERE DIVERSE LAVORAZIONI**

**ELEVATE PRESTAZIONI E DURATA NEL TEMPO:**

utensili di elevata qualità, in acciaio al cromo vanadio

**ORDINE E PRATICITÀ:** forniti in comoda e robusta valigetta

con clip di chiusura in metallo ed indicazione della misura

e del profilo per ciascuna chiave,

per essere sempre ordinati e pronti all'uso.

**FG 625TX/S77**

€/LISTINO

~~295,00~~

**PROMO  
179,00€**

**SET 77 UTENSILI TORX E TORX PLUS  
- ATTACCO 1/4", 3/8", 1/2"**

3/8"

1/4"

1/2"

**CONTENUTO**

		TX	1/4": TX6, 8, 10, 15, 20, 25, 27, 30 3/8": TX40, 45, 47, 50, 55 1/2": TX60, 70
		TX CON FORO	1/4": T8H, 10, 15, 20, 25, 27, 30 3/8": T40H, 45, 50, 55 1/2": T60H
		TX ESTERNO	1/4": E4, 5, 6, 7, 8 3/8": E10, 12, 14, 16 1/2": E18, 20, 22, 24
		TX IP	1/4": 8IP, 10, 15, 20, 25, 27, 30 3/8": 40IP, 45, 50 1/2": 55IP, 60
		TX IPR	1/4": 8IPR, 10, 15, 20, 25, 27, 30 3/8": 40IPR, 45, 50 1/2": 55IPR, 60
		TX PLUS ESTERNO	1/4": EP4, 5, 6, 7, 8 3/8": EP10, 12, 14, 16 1/2": EP18, 20, 22, 24



**FG 150TX/S32**

€/LISTINO

~~201,00~~

**PROMO  
119,00€**

**SET 32 INSERTI A BUSSOLA CON  
IMPRONTA TORX - ATTACCO 1/2"**



**CONTENUTO**

	FG 150/TX	20 - 70
	FG 150L/TX	20 - 70
	FG 150XL/TX	40 - 70
	FG 150XXL/TX	40 - 70





# CHIAVI A BUSSOLA



## FG 150M/S26

€/LISTINO

~~185,50~~

PROMO  
**99,00€**

SET 26 INSERTI A BUSSOLA CON  
IMPRONTA XZN - ATTACCO 1/2"



### CONTENUTO

	FG 150/M	5 - 16
	FG 150L/M	5 - 16
	FG 150XL/M	5 - 14
	FG 150XXL/M	8 - 14



## FG 150H/S30

€/LISTINO

~~185,00~~

PROMO  
**99,00€**

SET 30 INSERTI A BUSSOLA CON IMPRONTA ESAGONALE  
- ATTACCO 1/2"



### CONTENUTO

	FG 150/H	5 - 19
	FG 150L/H	5 - 13
	FG 150XL/H	5 - 14
	FG 150XXL/H	5 - 12



## FG 629A/S15

€/LISTINO

~~639,00~~

PROMO  
**339,00€**

SET 15 CHIAVI A BUSSOLA ESAGONALI  
- ATTACCO 3/4"



### CONTENUTO

	FG 629/A	19,22,24,27,30,32,36,41,46,50,60mm
	FG 629/CR34	
	FG 629/SN34	
	FG 629/ES34	
	FG 629/PR200	



## FG 629B/S15

€/LISTINO

~~639,00~~

PROMO  
**339,00€**

SET 15 CHIAVI A BUSSOLA POLIGONALI - ATTACCO 3/4"



### CONTENUTO

	FG 629/B	19,22,23,27,30,32,36,41,46,50,60mm
	FG 629/CR34	
	FG 629/SN34	
	FG 629/ES34	
	FG 629/PR200	

**FG 152/RTXS10**

€/LISTINO  
~~170,00~~

**PROMO**  
**99,00€**

SET 10 INSERTI A BUSSOLA RINFORZATI TORX - ATTACCO 1/2"  
Contenuto:  
RTX20, RTX25, RTX27, RTX30, RTX40, RTX45, RTX50, RTX55, RTX60, RTX70



**FG 152RH/S9**

€/LISTINO  
~~129,00~~

**PROMO**  
**69,00€**

SET 9 INSERTI A BUSSOLA RINFORZATI ESAGONALI - ATTACCO 1/2"  
Contenuto:  
RH5, RH6, RH7, RH8, RH10, RH12, RH14, RH17, RH19



**FG 152RM/S9**

€/LISTINO  
~~130,00~~

**PROMO**  
**69,00€**

SET 9 INSERTI A BUSSOLA RINFORZATI XZN - ATTACCO 1/2"  
Contenuto:  
RM5, RM6, RM8, RM9, RM10, RM12, RM14, RM16, RM18



**FG 629C/S10**

€/LISTINO  
~~319,50~~

**PROMO**  
**179,00€**

SET 10 CHIAVI A BUSSOLA ESAGONALI RINFORZATE  
- ATTACCO 3/4"  
Contenuto: 17,19,22,24,27,30,32,36,41,46mm



**FG 630A/S14**

€/LISTINO  
~~896,50~~

**PROMO**  
**499,00€**

SET 14 CHIAVI A BUSSOLA ESAGONALI RINFORZATE  
- ATTACCO 1"  
Contenuto: 24,27,30,32,33,34,36,38,41,46,50,55,60,65mm



**FG 628/S6**

€/LISTINO  
~~98,00~~

**PROMO**  
**59,00€**

SET 6 CHIAVI A BUSSOLA ESAGONALI RINFORZATE PIATTE  
- ATTACCO 1/2"  
Contenuto: 22,23,24,27,30,32mm



**CHIAVE  
A BUSSOLA  
DA 1/2"  
ESAGONALE  
RINFORZATA**



**EXTRA-PIATTA**

**FG 628/S12**

€/LISTINO  
~~134,00~~

**PROMO**  
**79,00€**

SET 12 CHIAVI A BUSSOLA ESAGONALI RINFORZATE PIATTE  
- ATTACCO 1/2"  
Contenuto: 10,11,12,13,14,15,16,17,18,19,20,21mm





GIRAVITI E PINZE

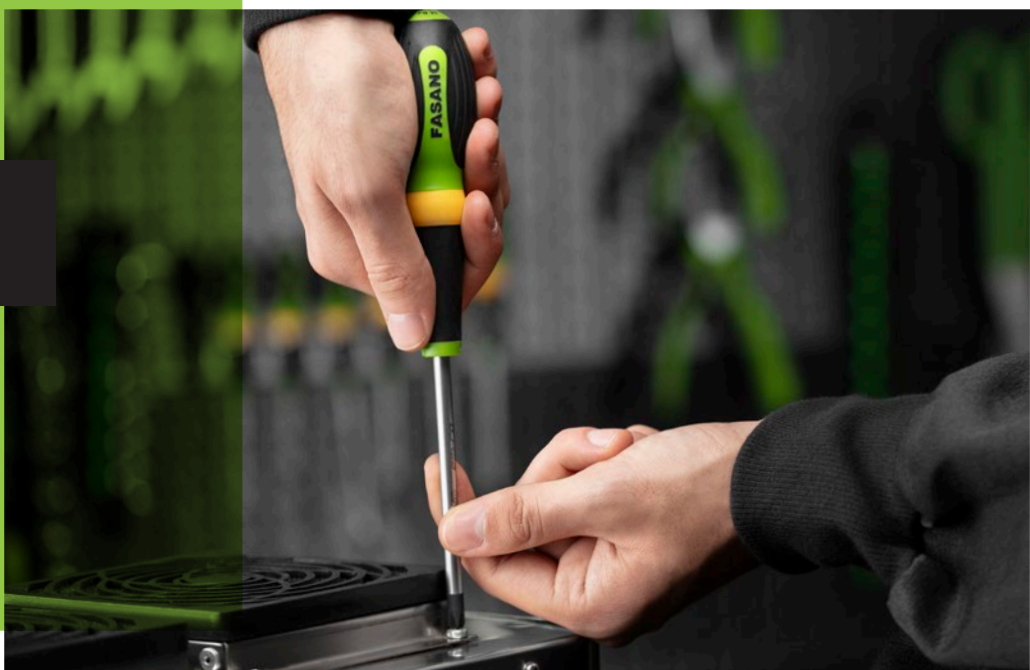

FG 22/S6

€/LISTINO

~~36,00~~

PROMO 21,90€

SET GIRAVITI PER VITI CON TESTA A INTAGLIO E A CROCE PHILLIPS

Contenuto: 3x75, 4x100, 5.5x100, PH0x60, PH1x80, PH2x100



FG 22/S8

€/LISTINO

~~48,00~~

PROMO 27,90€

SET GIRAVITI PER VITI CON TESTA A INTAGLIO E A CROCE PHILLIPS

Contenuto: 3x75, 4x100, 5.5x100, 6.5x30, PH0x60, PH1x80, PH2x100, PH2x30



FG 22/S8B

€/LISTINO

~~52,00~~

PROMO 31,90€

SET GIRAVITI PER VITI CON TESTA A INTAGLIO E A CROCE PHILLIPS

Contenuto: 2.5x75, 3.5x100, 4x100, 6.5x150, 8x150, PH0x60, PH1x80, PH2x150



FG 22/S12

€/LISTINO

~~90,00~~

PROMO 53,90€

SET GIRAVITI PER VITI CON TESTA A INTAGLIO E A CROCE PHILLIPS

Contenuto: 2.5x60, 3x75, 4x100, 5.5x150, 6.5x150, 8x150, 4x30, PH0x60, PH1x80, PH2x100, PH3x150, PH1x30



**FG 22TX/S6**

€/LISTINO

~~66,50~~

**PROMO**  
**39,90€**

SET GIRAVITI PER VITI CON IMPRONTA TORX

Contenuto: TX10, TX15, TX20, TX25, TX27, TX30



**FG 22FX/S10**

€/LISTINO

~~147,00~~

**PROMO**  
**89,90€**

SET GIRAVITI A BUSSOLA ESAGONALE CON ASTA FISSA

Contenuto: 5, 5.5, 6, 7, 8, 9, 10, 11, 12, 13 mm



**FG 22RTX/S8**

€/LISTINO

~~94,50~~

**PROMO**  
**49,90€**

SET GIRAVITI PER VITI CON IMPRONTA TAMPER RESISTANT TORX

Contenuto: RTX10, RTX15, RTX20, RTX25, RTX27, RTX30, RTX40, RTX45



**FG 139**

€/LISTINO

~~32,00~~

**PROMO**  
**22,90€**

SET 12 CHIAVI MASCHIO A L CON IMPRONTA ESAGONALE SFERICA - SERIE CORTA

Contenuto: 1.5, 2, 2.5, 3, 4, 4.5, 5, 5.5, 6, 7, 8, 10 mm



**FG 139/B**

€/LISTINO

~~16,50~~

**PROMO**  
**9,90€**

SET 10 CHIAVI MASCHIO ESAGONALI A L - SERIE CORTA

Contenuto: 1.5, 2, 2.5, 3, 4, 5, 5.5, 6, 8, 10 mm



TESTA SFERICA



**FG 139/L**

€/LISTINO

~~41,50~~

**PROMO**  
**24,90€**

SET 12 CHIAVI MASCHIO A L CON IMPRONTA ESAGONALE SFERICA - SERIE LUNGA

Contenuto: 1.5, 2, 2.5, 3, 4, 4.5, 5, 5.5, 6, 7, 8, 10 mm



TESTA SFERICA

**FG 139/C**

€/LISTINO

~~24,50~~

**PROMO**  
**14,90€**

SET 10 CHIAVI MASCHIO ESAGONALI A L - SERIE LUNGA

Contenuto: 1.5, 2, 2.5, 3, 4, 5, 5.5, 6, 8, 10 mm



**FG 142/S9**

€/LISTINO

~~128,00~~

**PROMO**  
**76,90€**

SET 9 CHIAVI MASCHIO CON IMPUGNATURA BI-MATERIALE E IMPRONTA ESAGONALE SFERICA

Contenuto: 2, 2.5, 3, 4, 5, 6, 7, 8, 10mm



**FG 139/LM**

€/LISTINO

~~56,00~~

**PROMO**  
**33,90€**

SET 10 CHIAVI MASCHIO ESAGONALI A L

Contenuto: 1.5, 2, 2.5, 3, 4, 5, 6, 7, 8, 10 mm



ESTREMITÀ MAGNETICA



## FG 138/BP

€/LISTINO

~~62,00~~

PROMO  
**36,90€**

SET 9 CHIAVI MASCHIO TORX A L E TESTA SFERICA

Contenuto: TX8, 10, 15, 20, 25, 27, 30, 40, 50



TESTA SFERICA

## FG 138/B

€/LISTINO

~~34,00~~

PROMO  
**19,90€**

SET 10 CHIAVI MASCHIO A L CON IMPRONTA TORX

Contenuto: TX9, TX10, TX15, TX20, TX25, TX27, TX30, TX40, TX45, TX50 - SERIE CORTA



## FG 138/M

€/LISTINO

~~62,00~~

PROMO  
**37,90€**

SET 9 CHIAVI MASCHIO A L CON IMPRONTA TORX

Contenuto: TX10, TX15, TX20, TX25, TX27, TX30, TX40, TX45, TX50



ESTREMITÀ MAGNETICA

## FG 138/C

€/LISTINO

~~37,00~~

PROMO  
**19,90€**

SET 10 CHIAVI MASCHIO A L CON IMPRONTA TORX

Contenuto: TX9, TX10, TX15, TX20, TX25, TX27, TX30, TX40, TX45, TX50 - SERIE LUNGA



## FG 138

€/LISTINO

~~55,00~~

PROMO  
**32,90€**

SET 12 CHIAVI MASCHIO A L CON IMPRONTA TORX

Contenuto: TX7, 8, 9, 10, 15, 20, 25, 27, 30, 40, 45, 50



## FG 88/25-S31

€/LISTINO

~~98,00~~

PROMO  
**59,00€**

SET 30 INSERTI RINFORZATI DA 1/4" E PORTA INSERTI MAGNETICO

Contenuto: PH1, PH2, PH3 (x2);

PZ1, PZ2, PZ3;

SQ1, SQ2, SQ3;

T8, T9, T10, T15, T20, T25, T27, T30, T40;

H2, H3, H4, H5, H6, H8;

SL4, SL5.5, SL8

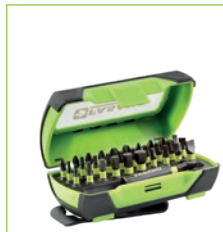

## FG 143TX/S6

€/LISTINO

~~82,00~~

PROMO  
**49,90€**

SET 6 CHIAVI MASCHIO TORX CON IMPUGNATURA BI-MATERIALE

Contenuto: TX10, TX15, TX20, TX25, TX30, TX40



**FG 85/175-S9**

€/LISTINO

~~92,00~~

**PROMO**  
**59,90€**

**SET 8 GIRAVITI BIVALENTI E 1 IMPUGNATURA DI MANOVRA**

Contenuto: FG 85/175FPH0, PH1, PH2 (SL 4, 5.5, 6.5mm - PH 0, 1, 2)

- FG 85/175T6-8, T7-9, T10-15, T20-25, T30-40

- FG 85/IM



**FG 85/175-S10**

€/LISTINO

~~92,00~~

**PROMO**  
**59,90€**

**SET 9 GIRAVITI BIVALENTI E 1 IMPUGNATURA DI MANOVRA**

Contenuto: FG 85/175FPH0, PH1, PH2 (SL 4, 5.5, 6.5mm - PH 0, 1, 2)

- FG 85/175PZ1-2 (PZ1-2) - FG 85/175H2.5, H3,H4,H5,H6

- FG 85/IM



**FG 59XT/S3**

€/LISTINO

~~89,50~~

**PROMO**  
**49,90€**

**SET 3 PINZE ASSORTITE INDUSTRIAL**

Contenuto: FG 59/XT180, FG 63/XT160, FG 61/XT160

**FG 59XT/S3B**

€/LISTINO

~~99,50~~

**PROMO**  
**59,90€**

**SET 3 PINZE ASSORTITE INDUSTRIAL**

Contenuto: FG 63/H180, FG 61/XT200, FG 59/XT180



**FG 58/C250**

€/LISTINO

~~40,00~~

**PROMO**  
**23,90€**

**PINZA REGOLABILE A CERNIERA CHIUSA CON SCORRIMENTO RAPIDO**

mm - pollici: 250 - 10"

HRC: 54-58



INNOVATIVO SISTEMA DI SCORRIMENTO  
SENZA PULSANTE CON MECCANISMO  
AUTOBLOCCANTE, PER ADATTARSI  
RAPIDAMENTE AI DIVERSI  
DIAMETRI DEI TUBI



**FG 51/S4**

€/LISTINO

~~99,80~~

**PROMO**  
**56,90€**

**SET 4 PINZE PER ANELLI ELASTICI 10-25MM**

Contenuto: FG 51/140, FG 52/140, FG 53/140, FG 54/140

**FG 51/S4B**

€/LISTINO

~~105,00~~

**PROMO**  
**62,90€**

**SET 4 PINZE PER ANELLI ELASTICI 19-60MM**

Contenuto: FG 51/180, FG 52/180, FG 53/180, FG 54/180



**FG 55/S4**

€/LISTINO

~~140,00~~

**PROMO**  
**79,90€**

**SET 4 PINZE PER ANELLI ELASTICI CON INSERTI RINFORZATI IN ACCIAIO 10-25MM**

Contenuto: FG 55/140, FG 56/140, FG 57/140, FG 58/140

**FG 55/S4B**

€/LISTINO

~~145,00~~

**PROMO**  
**84,90€**

**SET 4 PINZE PER ANELLI ELASTICI CON INSERTI RINFORZATI IN ACCIAIO 19-60MM**

Contenuto: FG 55/180, FG 56/180, FG 57/180, FG 58/180



INSERTI RINFORZATI PER ANELLI DI GRANDE TENUTA



ELETTRONICA ED ELETTROTECNICA



FG 22E/S6

€/LISTINO ~~60,00~~

PROMO 36,90€

SET 6 GIRAVITI ISOLATI

Contenuto: 3x100, 4x100, 5.5x125, PH0x60, PH1x80, PH2x100



FG 22E/SZ6

€/LISTINO ~~60,00~~

PROMO 36,90€

SET 6 GIRAVITI ISOLATI

Contenuto: 3x100, 4x100, 5.5x125, PZ0x60, PZ1x80, PZ2x100



FG 59IS/S3

€/LISTINO ~~125,00~~

PROMO 69,90€

SET 3 PINZE ASSORTITE CON MANICI ISOLATI

Contenuto: FG 59/IS180, FG 61/IS200, FG 63/IS160



FG 68/SP

€/LISTINO ~~36,00~~

PROMO 21,90€

PINZA TAGLIA E SPELLAFILI PER CAPICORDA ISOLATI

Ø/mm²: 0.2-6  
AWG: 8-24  
L/mm: 205



FG 68/SP2

€/LISTINO ~~20,00~~

PROMO 11,90€

SPELLAFILI FRONTALE, DOTATA DI INCAVO SPELLAFILI

Ø/mm²: 0.2-6  
AWG: 27-17  
L/mm: 175



FG 68U/S439

€/LISTINO ~~298,00~~

PROMO 179,00€

SET PINZA UNIVERSALE + 3 MATRICI (FG 68/MAT4, MAT16, MAG) CON ASSORTIMENTO 435 CAPICORDA ISOLATI



**FG 96/DG**

€/LISTINO  
~~200,00~~

**PROMO**  
**119,00€**



**MULTIMETRO DIGITALE DC/AC - OHM**  
Classe II  
Categoria sovratensione: CAT III 300V  
Test di continuità  
Frequenza: 10Hz-200kHz  
Prova diodi  
Duty cycle 5%-95% RH (± 0.1%)  
Temperatura -20°C/400°C (± 1.5% ± 3.0°C)  
/ 400°C/1000°C (± 2.0% ± 3.0°C)  
Misurazione Lux 4.000 Lux (± 1) /  
40.000 Lux (± 10)  
Capacità rilevazione umidità 30%-90% RH  
(± 0.1%)  
Capacità di rilevazione suono 35 - 100dB  
(± 0.1dB)  
Stand by dopo 15 minuti  
Indicatore di livello batteria  
Batteria da 9 V



DC	AC	Ω	LXPXH/MM
400mV-300V	4V-300V	400Ω-40MΩ	165x80x35

**FG 98/DG**

€/LISTINO  
~~350,00~~

**PROMO**  
**199,00€**



**MULTIMETRO DIGITALE**  
Classe II  
Categoria sovratensione: CAT III 600V  
Prova diodi  
Test di continuità  
Tecnologia NCV  
Possibilità di memorizzare i dati  
Display LCD  
Luce led posta sul retro per illuminare  
area di lavoro  
Cover protettiva rimovibile in gomma  
Auto spegnimento dopo 10 minuti di inutilizzo  
Puntali in dotazione  
Alimentazione: 1 batteria tipo AAA da 1.5V



DC	AC	Ω	LXPXH/MM
6V-1000V	6V-750V	600Ω-60MΩ	184x90x46

**FG 97/DG**

€/LISTINO  
~~140,00~~

**PROMO**  
**79,00€**



**MULTIMETRO DIGITALE SMART**  
Classe II  
Categoria sovratensione: CAT IV 600V;  
CAT III 1000V  
Frequenza: 100 kHz  
Frequenza di campionamento 3 volte  
al secondo  
Possibilità di memorizzare i dati  
Display LCD  
Prova diodi  
Luce led per illuminare area di lavoro  
Base di appoggio  
Gancio di appendimento  
Vano porta puntali sul retro  
Auto spegnimento dopo 15 minuti di inutilizzo  
Puntali e sonda in dotazione  
Alimentazione: 1 batteria da 9V tipo 6F22



DC	AC	Ω	LXPXH/MM
600mV-600V	6V-600V	600Ω-60MΩ	148x76x21

**FG 99/DG**

€/LISTINO  
~~260,00~~

**PROMO**  
**149,00€**



**PINZA AMPEROMETRICA DIGITALE**  
Classe II  
Categoria sovratensione: CAT III 600V  
Frequenza di campionamento 3 volte al secondo  
Prova diodi  
Tecnologia NCV  
Auto spegnimento dopo 15 minuti di inutilizzo  
Luce led frontale per illuminare area di lavoro  
Display LCD  
Temperatura: -20°C ÷ 1000°C (-4°F ÷ 1832°F)  
Frequenza: 10Hz; 100Hz; 1000Hz; 10kHz;  
100kHz; 1000kHz; 10MHz  
Custodia, puntali e sonda in dotazione  
Alimentazione: 3 batterie da 1.5V TIPO AAA



DC	AC	Ω	LXPXH/MM
600mV-600V	6V-600V	600Ω-60MΩ	194x59x29

**UTENSILI  
DINAMOMETRICI**

**CHIAVI DINAMOMETRICHE A DISINNESTO E ATTACCO QUADRO**

 Precisione  $\pm 4\%$ 

Fornite con verbale di taratura



CODICE	RISOLUZIONE NM	ATTACCO	NM	€/LISTINO	€/PROMO
FG 531	0.1	1/4"	5-25	215,00	129,00
FG 533/2	0.25	3/8"	10-50	240,00	145,00
FG 536/1	0.5	1/2"	20-100	240,00	145,00
FG 536/2	1.0	1/2"	40-200	250,00	149,00
FG 536/3	2.0	1/2"	60-340	275,00	169,00

**CHIAVE DINAMOMETRICA CON CRICCHETTO REVERSIBILE PER SERRAGGI DESTORSI E SINISTRORSI**

 Precisione  $\pm 4\%$  - Fornita in cassetta di ABS

Testa a cricchetto con rilascio rapido

Impugnatura ergonomica con anello di regolazione

Fornita con verbale di taratura



CODICE	RISOLUZIONE NM	ATTACCO	NM	€/LISTINO	€/PROMO
FG 540/1	2.5	3/4"	150-750	1.050,00	639,00
FG 540/2	2.5	3/4"	200-1000	1.200,00	729,00
FG 540/3	1.5	1"	200-1000	1.400,00	849,00

**BARRA DINAMOMETRICA A DISINNESTO PER SERRAGGI DESTORSI E SINISTRORSI**

 Precisione  $\pm 4\%$ 

Fornita con verbale di taratura

Fornita in cassetta di ABS



CODICE	NM	ATTACCO	€/LISTINO	€/PROMO
FG 538/1	140-560	3/4"	800,00	489,00
FG 538/2	200-800	3/4"	880,00	539,00
FG 539/1	200-1000	1"	1.150,00	699,00



**CHIAVE DINAMOMETRICA DIGITALE PER NM E GRADI - 1/2"**

Precisione di serraggio  $\pm 4\%$   
Destorsa e Sinistrorsa  
Doppia manualità di misurazione: PICCO e TRACCIA  
Indicatore sonoro e visivo a 12 led al raggiungimento della coppia prefissata  
Possibilità di memorizzare fino a 250 differenti serraggi grazie al software PC incluso nel kit  
Interfaccia PC tramite presa USB  
Possibilità di impostare fino a 9 serraggi predefiniti  
Alimentazione: 2 batterie 1.5V

1/2"



CODICE	NM	€/LISTINO	€/PROMO
FG 543/DG1	6.8-135	650,00	399,00
FG 543/DG2	10-200	770,00	469,00



**FG 546/DG**

€/LISTINO  
~~330,00~~

**PROMO**  
**199,00€**

**GONIOMETRO DIGITALE PER SERRAGGI IN COPPIA E ANGOLARI**

Precisione di serraggio  $\pm 2\%$   
Destorso e Sinistrorso  
Doppia modalità di misurazione: PICCO e TRACCIA  
Indicatore sonoro e visivo a 6 led al raggiungimento della coppia prefissata  
Possibilità di memorizzare fino a 50 differenti serraggi  
Alimentazione: 2 batterie 1.5V

1/2"



**FG 547/DG**

€/LISTINO  
~~210,00~~

**PROMO**  
**129,00€**

**GONIOMETRO DIGITALE PER SERRAGGI ANGOLARI**

Precisione di serraggio  $\pm 2\%$   
Destorso e Sinistrorso  
Indicatore sonoro e visivo a 6 led al raggiungimento della coppia prefissata  
Dotato di supporto magnetico posteriore



**CHIAVE DINAMOMETRICA A INNESTO FEMMINA**

Precisione  $\pm 4\%$   
Fornita con verbale di taratura



CODICE	NM	RISOLUZIONE	■ X □	L/MM	€/LISTINO	€/PROMO
FG 544/1	5-25	0.1	9x12	259	195,00	119,00
FG 544/2	10-50	0.25	9x12	385	216,00	129,00
FG 544/3	20-100	0.5	9x12	385	232,00	139,00
FG 544/4	40-200	1.0	14x18	480	278,00	169,00



**MOLTIPLICATORE DI COPPIA DESTORSO/SINISTRORSO**

CODICE	■ X □	RAPPORTO	NM	Ø/MM	€/LISTINO	€/PROMO
FG 581/A	1/2" x 3/4"	1:6.5	231-1.500	80	850,00	529,00
FG 581/B	1/2" x 1"	1:12	208-2.500	80	1.320,00	799,00

**UTENSILI  
DA TAGLIO**

**FG 70/S110**

€/LISTINO  
~~335,00~~

**PROMO**  
**199,00€**

**SET 110 MASCHI E FILIERE IN ACCIAIO AL CROMO + ACCESSORI**  
Passo grosso e fine filettatura metrica



						ACCESSORI
2x.04	6x0.75	12x1	2x0.4	6x0.75	12x1	GF25x9
3x0.5	7x0.75	12x1.25	3x0.5	7x0.75	12x1.25	GF8x14
4x0.7	8x0.75	12x1.5	4x0.7	8x0.75	12x1.5	GMM1.5
5x0.8	8x1	14x1	5x0.8	8x1	14x1	GMM3
6x1	9x0.75	14x1.25	6x1	9x0.75	14x1.25	GMC1
7x1	9x1	14x1.5	7x1	9x1	14x1.5	
8x1.25	10x0.75	16x1	8x1.25	10x0.75	16x1	
9x1.25	10x1	16x1.5	9x1.25	10x1	16x1.5	
10x1.5	10x1.25	18x1.5	10x1.5	10x1.25	18x1.5	
11x1.5	11x0.75		11x1.5	11x0.75		
12x1.75	11x1		12x1.75	11x1		
14x2	11x1.25		14x2	11x1.25		
16x2	12x0.75		16x2	12x0.75		

**FG 81HSS/S3**

€/LISTINO  
~~260,00~~

**PROMO**  
**159,00€**

**SET 3 FRESE CONICHE IN ACCIAIO HSS**  
4-12mm, 4-20mm, 4-30mm

**FG 75CO/S25**

€/LISTINO  
~~245,00~~

**PROMO**  
**149,00€**

**SET PUNTE ELICOIDALI CILINDRICHE IN ACCIAIO HSS-COBALTO 5% RETTIFICATO**  
Contenuto: 1-13x0.5mm



**FG 49/L**

€/LISTINO  
~~18,00~~

**PROMO**  
**10,90€**

**FORBICI MULTIUSO A LAME LUNGHE IN ACCIAIO INOX**

L/mm 200  
Lama 87mm  
Apertura max 151mm  
HRC: 52-54



**FG 49/MU**

€/LISTINO  
~~26,50~~

**PROMO**  
**15,90€**

**FORBICI MULTIUSO CON GOLA SPELLAFILI E LAME IN ACCIAIO INOX ZIGRINATE**

HRC: 52-54  
L/mm 203 - Lama 52mm



**FG 49/TC**

€/LISTINO  
~~44,00~~

**PROMO**  
**26,90€**

**FORBICI DA ELETTRICISTA DOTATE DI INCAVO SPELLAFILI**

L/mm 140 - Lama 65mm  
Lama microdentata in acciaio  
HRC: 56  
Struttura integrale in acciaio Inox  
Tagliacavi 12mm  
Con supporto per cintura



SUPPORTO PER CINTURA



STRUTTURA INTERAMENTE IN ACCIAIO FORGIATO

**FG 49/CF**

€/LISTINO  
~~32,00~~

**PROMO**  
**17,90€**

**FORBICI DA ELETTRICISTA CON CRIMPATORE PER TERMINALI A TUBETTO**

L/mm 155 - Lama 45mm  
Lama in acciaio  
HRC 52-54  
Capacità tagliacavi 12mm  
Dotate di incavo spellafili e crimpatore per terminali a tubetto



CRIMPATORE PER TERMINALI A TUBETTO

**FG 48/B**

€/LISTINO  
~~23,00~~

**PROMO**  
**13,90**

**CUTTER A SERRAMANICO CON LAMA TRAPEZOIDALE**

L/mm: 110-180  
Fornito con 3 lame di ricambio



**FG 48/C**

€/LISTINO  
~~9,60~~

**PROMO**  
**5,90**

**CUTTER PROFESSIONALE CON LAMA LUNGA**

L/mm: 154

**NEW**



**FG 48/P**

€/LISTINO  
~~14,50~~

**PROMO**  
**8,90**

**CUTTER PROFESSIONALE A STILO**

L/mm: 142  
Fornito con 3 lame di ricambio



**FG 49/TCX**

€/LISTINO  
~~58,50~~

**PROMO**  
**35,90€**

**FORBICI DA ELETTRICISTA DOTATE DI INCAVO SPELLAFILI**

L/mm 160 - Lama 50mm  
Lama microdentata in acciaio  
HRC: 56  
Struttura integrale in acciaio Inox  
Tagliacavi 15mm  
Con supporto per cintura



SUPPORTO PER CINTURA



STRUTTURA INTERAMENTE IN ACCIAIO FORGIATO

**FG 77/PVC4**

€/LISTINO  
~~50,00~~

**PROMO**  
**29,90€**

**TRONCATUBI A CRICCO**

Sistema a cremagliera con avanzamento progressivo  
Dotata di piattaforma in nylon che facilita il taglio di profili piatti  
Per tubi in PVC  
Ømm: 0-42



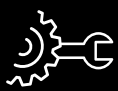

## MANUTENZIONE GENERALE



FLESSOMETRO CON CASSA IN ABS ANTI-SHOCK E NASTRO IN ACCIAIO RIVESTITO IN NYLON  
Classe II



CODICE	L/MT	BANDA MM	€/LISTINO	€/PROMO
FG 44/MT3	3	16	11,50	6,90€
FG 44/MT5	5	25	18,00	10,90€
FG 44/MT8	8	25	24,50	14,90€
FG 44/MT10	10	25	29,50	17,90€

### FG 95/DG

€/LISTINO  
~~96,00~~

PROMO  
**57,90€**

CALIBRO A CORSOIO DIGITALE, LETTURA CINQUANTESIMALE  
L/mm: 155

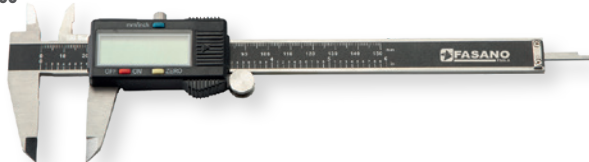

### FG 95/CA

€/LISTINO  
~~52,00~~

PROMO  
**29,90€**

CALIBRO A CORSOIO, LETTURA CINQUANTESIMALE

Scala cromata  
Asta sottile  
Bloccaggio a vite  
Inox temprato  
L/mm: 150

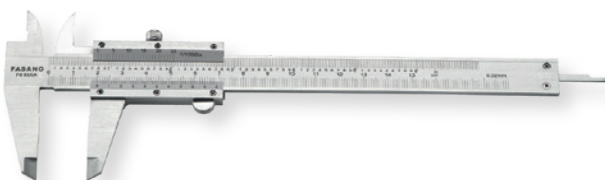

### FG 128/S11

€/LISTINO  
~~122,00~~

PROMO  
**72,90€**

SET 11 UTENSILI DA PERCUSSIONE CON IMPUGNATURA  
Contenuto: FG 128/SC12, FG 128/SC16, FG 128/PU2, FG 128/PU10



### FG 128C/S6

€/LISTINO  
~~42,00~~

PROMO  
**28,90€**

SET 6 CACCIASPINE  
Misure: 2, 3, 4, 5, 6, 8mm



**FG 47/S3**

€/LISTINO

~~61,00~~

**PROMO**  
**36,90€**

**SET 3 RASCHIETTI A BATTERE CON LAMA IN ACCIAIO INOX**  
Lama in acciaio Inox  
Impugnatura dotata di testa in acciaio per utilizzo a battere  
Impugnatura in polipropilene con rivestimento in gomma anti-scivolo  
Dotato di foro per appendimento



**FG 125/S3**

€/LISTINO

~~70,00~~

**PROMO**  
**39,90€**

**SET 3 LEVE A PERCUSSIONE**  
Contenuto: 300, 450, 600mm



**FG 126/S3**

€/LISTINO

~~35,00~~

**PROMO**  
**19,90€**

**SET 3 MINI LEVE CON ESTREMITÀ INCLINATA**  
L'angolo inclinato a 25° consente l'accesso anche nei punti più difficili  
Estremità a battere sulla leva Ø/mm 6

**NEW**



**FG 93/M50**

€/LISTINO

~~31,00~~

**PROMO**  
**18,90€**

**SPECCHIETTO TELESCOPICO E ARTICOLATO IN ACCIAIO**  
Ø/mm specchietto 50  
L/mm asta 240-698



**FG 93/M95**

€/LISTINO

~~31,00~~

**PROMO**  
**18,90€**

**SPECCHIETTO TELESCOPICO E ARTICOLATO IN ACCIAIO**  
Dimensioni specchietto mm 50x95  
L/mm asta 370-775



**FG 92/GR**

€/LISTINO

~~28,00~~

**PROMO**  
**16,90€**

**PROLUNGA MAGNETICA FLESSIBILE**  
Capacità 1 Kg  
L/mm 700  
Dotata di griffe prensili

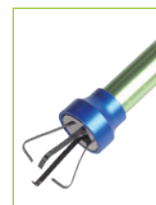
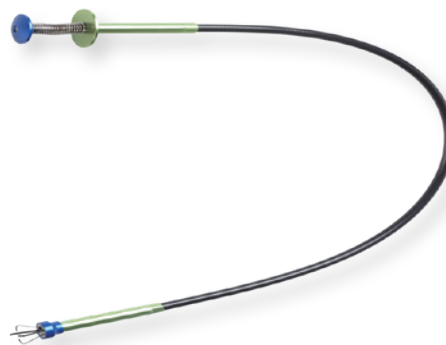

CON GRIFFE PRENSILI

**FG 92/PM**

€/LISTINO

~~21,00~~

**PROMO**  
**12,90€**

**PROLUNGA MAGNETICA FLESSIBILE**  
Impugnatura in gomma antiscivolo  
Asta 1 metro  
Ø/mm 3,9



**FG 92/PF**

€/LISTINO

~~27,50~~

**PROMO**  
**15,90€**

**PROLUNGA MAGNETICA ARTICOLATA**  
Capacità 3,5 kg  
L/mm asta 400  
Ø/mm 1,5  
Punta magnetica



**FG 92/PM4**

€/LISTINO

~~27,50~~

**PROMO**  
**14,90€**

**PROLUNGA MAGNETICA TELESCOPICA**  
L/mm 165-622  
Impugnatura in PVC antiscivolo  
Capacità 2.3kg



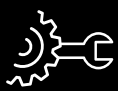

## FG 98/GAS

€/LISTINO  
~~140,00~~

PROMO  
**85,00€**

### SALDATORE PORTATILE A GAS

Temperatura: 210-400 °C

25-80 Watt

Autonomia 120 minuti

Dotato di 4 beccucci per saldatura, taglio, fiamma, soffio

Fornito in box di ABS



## FG 98/LT

€/LISTINO  
~~188,00~~

PROMO  
**115,00€**

### SALDATORE PORTATILE CON BATTERIA AL LITIO

Temperatura max: 600 °C

Autonomia 40 minuti

Tempo di ricarica 3.5h

Fornito con punte per saldare, tagliare e soffiare

Fornito in box di ABS

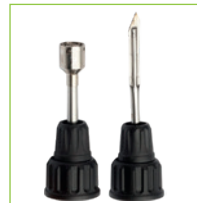

## FG 96/SS36

€/LISTINO  
~~65,00~~

PROMO  
**39,90€**

### SALDATORE A STILO A DOPPIA POTENZA

Classe di protezione I

30/60 Watt - 230V - Ø/mm 5.8



## FG 494/S12

€/LISTINO  
~~55,00~~

PROMO  
**32,90€**

### PISTOLA PER COLLA A CALDO

Potenza nominale di riscaldamento 80W

Temperatura di esercizio: 193°C (383 °F)

Tempo di riscaldamento: 3/5 minuti

Lunghezza stick colla: 200mm

Diametro stick colla: 11.5mm

Fornita in box di ABS con 12 stick colla inclusi



## FG 493/AL

€/LISTINO  
~~47,00~~

PROMO  
**28,90€**

### PISTOLA PER SIGILLANTE CON TUBO IN ALLUMINIO

L/mm 240

Dotata di sistema anti-goccia

Capacità 300cc



## FG 493/N

€/LISTINO  
~~39,00~~

PROMO  
**23,90€**

### PISTOLA PER SIGILLANTE CON TUBO IN ACCIAIO

Corpo principale e meccanismo interno interamente in acciaio

Capacità 300cc



## FG 494/A180

€/LISTINO  
~~175,00~~

PROMO  
**99,00€**

### PISTOLA PER COLLA A CALDO

Dotata di piede d'appoggio per evitare che la punta riscaldata tocchi la superficie del piano di lavoro

Potenza nominale di riscaldamento 180W

Temperatura di esercizio 193°C

Tempo di riscaldamento 3/5 minuti

L/mm stick colla 100/250/350

Stick colla Ø/mm 11/11,5

Fornita con 1 beccuccio di ricambio



**FG 113/A**

€/LISTINO  
~~195,00~~

**PROMO**  
**119,00€**

**BAULE PORTA UTENSILI IN LAMIERA**  
Dotato di maniglioni laterali richiudibili  
Predisposizione per lucchetto di chiusura  
Struttura in lamiera d'acciaio 0.8mm  
Dimensioni 520x290x290 mm



**FG 113/B**

€/LISTINO  
~~210,00~~

**PROMO**  
**129,00€**

**BAULE PORTA UTENSILI IN LAMIERA**  
Dotato di maniglioni laterali richiudibili  
Predisposizione per lucchetto di chiusura  
Struttura in lamiera d'acciaio 0.8mm  
Dimensioni 650x350x350 mm



**FG 113/C**

€/LISTINO  
~~250,00~~

**PROMO**  
**149,00€**

**BAULE PORTA UTENSILI IN LAMIERA**  
Dotato di maniglioni laterali richiudibili  
Predisposizione per lucchetto di chiusura  
Struttura in lamiera d'acciaio 0.8mm  
Dimensioni 850x350x350 mm



**FG 113/D**

€/LISTINO  
~~325,00~~

**PROMO**  
**199,00€**

**BAULE PORTA UTENSILI IN LAMIERA**  
Dotato di maniglioni laterali richiudibili  
Predisposizione per lucchetto di chiusura  
Struttura in lamiera d'acciaio 0.8mm  
Dimensioni 1000x400x450 mm



**FG 111/AS104**

€/LISTINO  
~~863,50~~

**PROMO**  
**329,00€**

**CASSETTA PORTA-UTENSILI A 5 SCOMPARTI CON ASSORTIMENTO 104 UTENSILI**



**FG 111/A**

€/LISTINO  
~~62,00~~

**PROMO**  
**32,90€**

**CASSETTA PORTA-UTENSILI A 3 SCOMPARTI**

Predisposizione per lucchetto  
Divisorio scomparto superiore  
Struttura in lamiera  
Dimensioni 430x200x160 mm



**CASSETTA PORTA-UTENSILI A 5 SCOMPARTI**

Predisposizione per lucchetto  
Divisorio scomparto superiore  
Struttura in lamiera



CODICE	DIMENSIONI MM	€/LISTINO	€/PROMO
FG 111/B	430x200x200	75,00	39,90€
FG 111/C	530x200x200	94,00	49,90€

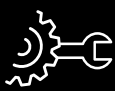

## FG 1450

€/LISTINO  
~~132,00~~

PROMO  
**79,90€**

### BORSA PORTA UTENSILI IN TESSUTO TECNICO 600D

Tessuto tecnico ad elevata resistenza  
Base semi rigida con rialzi in plastica  
Ampio vano centrale  
Tasche multiple interne ed esterne  
Tasca chiusa sul retro e doppia tasca chiusa frontale con passanti  
Tracolla imbottita regolabile



BASE SEMIRIGIDA



TASCA CHIUSA SUL RETRO



## FG 1456

€/LISTINO  
~~230,00~~

PROMO  
**139,00€**

### TROLLEY PORTA UTENSILI IN TESSUTO TECNICO 600D

Tessuto tecnico ad elevata resistenza  
Tasche interne ed esterne per un'ottimale organizzazione dello spazio  
Struttura rigida con ampio scomparto interno per l'alloggiamento di utensili e accessori  
Manico telescopico e 2 ruote resistenti per il facile trasporto  
2 tasche esterne frontali chiuse



AMPIO SCOMPARTO INTERNO



TESSUTO TECNICO AD ELEVATA RESISTENZA



## FG 1452

€/LISTINO  
~~145,00~~

PROMO  
**85,90€**

### CESTELLO PORTA UTENSILI IN TESSUTO TECNICO 600D CON COVER

Struttura rigida in tessuto tecnico ad elevata resistenza  
Base in plastica rigida per la protezione del contenuto  
Ampio scomparto aperto per facile accesso al contenuto  
Cover di chiusura con velcro a scomparsa  
Maniglione in metallo con impugnatura in gomma morbida  
Tasche multiple e passanti interni ed esterni  
Tasca chiusa laterale e tasca porta seghetto frontale  
Tracolla imbottita regolabile



TASCHE MULTIPLE



AMPIO SCOMPARTO CENTRALE APERTO



## FG 1460

€/LISTINO  
~~150,00~~

PROMO  
**89,00€**

### ZAINO PORTAUTENSILI IN TESSUTO TECNICO 600D

Tessuto tecnico ad elevata resistenza  
Base in plastica rigida per la protezione del contenuto  
Doppio vano interno, porta utensili e porta pc e documenti  
Tasche multiple laterali e frontali, interne ed esterne  
Schienale ergonomico imbottito  
Spallacci imbottiti e cinturino pettorale regolabile



DOPPIO VANO INTERNO CON PORTA PC



SPALLACCI IMBOTTITI



## FG 1454

€/LISTINO  
~~188,00~~

PROMO  
**109,00€**

### BORSA PORTA UTENSILI IN TESSUTO TECNICO 600D

Struttura rigida in tessuto tecnico ad elevata resistenza  
Base in plastica rigida per la protezione del contenuto  
Due ampi scomparti separati  
Tasche multiple e passanti interni ed esterni  
Tasche chiuse sul retro e sul fronte  
Comoda maniglia e tracolla imbottita regolabile



TASCHE MULTIPLE INTERNE



TASCA CHIUSA SUL RETRO



## FG 1465

€/LISTINO  
~~200,00~~

PROMO  
**119,00€**

### ZAINO PORTAUTENSILI IN TESSUTO TECNICO 600D CON RUOTE E SISTEMA TROLLEY

Tessuto tecnico ad elevata resistenza  
Spallacci imbottiti e cinturino pettorale regolabile e richiudibile in apposita tasca  
Doppio vano interno, porta utensili e porta pc e documenti  
Tasche multiple laterali e frontali, interne ed esterne  
Dimensioni bagaglio a mano  
Manico telescopico a scomparsa  
Ruote integrate con cover richiudibile  
Schienale ergonomico imbottito



DIMENSIONI BAGAGLIO A MANO



DOPPIO VANO INTERNO



**VALIGIA PORTAUTENSILI IN ABS**

Maniglione a scomparsa per facilitarne il trasporto  
Sistema di chiusura rinforzato  
Porta etichette  
Predisposizione per lucchetto di chiusura



IMPILABILI



PREDISPOSIZIONE PER LUCCHETTO DI CHIUSURA

CODICE	DIMENSIONI mm	€/LISTINO	€/PROMO
FG 1425	456x372x115	102,00	59,90
FG 1426	456x372x155	120,00	72,90
FG 1427	456x372x262	170,00	99,00

**FG 1434**

€/LISTINO  
~~145,00~~

**PROMO**  
**89,00€**

**VALIGIA PORTAUTENSILI DOTATA DI BOX INTERNI IN ABS**

Maniglione a scomparsa per facilitarne il trasporto  
Sistema di chiusura rinforzato  
Porta etichette  
Predisposizione per lucchetto di chiusura  
Dimensioni 456x372x115mm - Peso 3.2kg



**FG 109/L3**

€/LISTINO  
~~280,00~~

**PROMO**  
**139,00**

**CARRELLO PORTA OGGETTI PIEGHEVOLE**

Sistema di bloccaggio  
Dimensioni: 945x485x810mm  
Peso: 11kg  
Portata 300kg



**FG 1433**

€/LISTINO  
~~190,00~~

**PROMO**  
**99,00€**

**CARRELLO PIEGHEVOLE RICHIUDIBILE**

Ruote Ø 180 mm  
Struttura in ferro - base in alluminio  
Peso 6kg - Portata 100kg



DIMENSIONI DA CHIUSO:  
835X485X70mm



Base  
480x350mm

**FG 1445**

€/LISTINO  
~~45,00~~

**PROMO**  
**24,90€**

**BOX PORTAMINUTERIE DOTATO DI 8 CONTENITORI ASPORTABILI E DIVISORI REGOLABILI**

Dimensioni mm 385x320x60



**FG 1440**

€/LISTINO  
~~60,00~~

**PROMO**  
**29,90€**

**BOX PORTAMINUTERIE DOTATO DI 12 CONTENITORI ASPORTABILI**

Dimensioni mm 400x400x70



ILLUMINAZIONE



FG 202

€/LISTINO  
~~56,00~~

PROMO  
**33,90€**

LAMPADA RICARICABILE A LED CON TSC SYSTEM

LED di puntamento superiore  
TSC SYSTEM, tecnologia di spegnimento automatico al contatto con superfici  
Corpo in alluminio anodizzato  
Doppio magnete, sulla base e sul retro  
Gancio per cintura  
Cavo USB tipo C in dotazione  
Dimensioni 46x115 mm

MAX 1200 LUMEN



115mm



GANCIO POSTERIORE PER CINTURA



LED DI PUNTAMENTO SUPERIORE



TECNOLOGIA DI SPEGNIMENTO PER CONTATTO

FG 204

€/LISTINO  
~~32,50~~

PROMO  
**19,90€**

MINI LAMPADA PORTATILE A LED

Gancio per cintura  
Cavo USB tipo C in dotazione  
Dimensioni 21x89 mm

MAX 300 LUMEN

89mm



BASE MAGNETICA



DESIGN COMPATTO

FG 203

€/LISTINO  
~~18,00~~

PROMO  
**9,90€**

MINI FARETTO PORTATILE A LED

Dotato di magneti posteriori e doppia porta per ricarica  
Incluso cavo di ricarica USB tipo C  
Corpo in alluminio anodizzato  
Funzione dimmer  
Dimensioni: 28,4x32mm

MAX 100 LUMEN

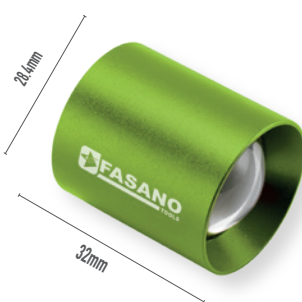

BASE MAGNETICA



DOPIA PORTA DI RICARICA TIPO C E MICRO USB

FG 214/L600

€/LISTINO  
~~85,00~~

PROMO  
**42,90€**

TORCIA RICARICABILE A LED

Cono luminoso regolabile  
Indicatore stato di ricarica  
In dotazione base di ricarica con supporto a parete e cavo USB  
Dimensioni 135x31mm



MAX 600 LUMEN



CONO LUMINOSO REGOLABILE



PIASTRA DI SUPPORTO A PARETE IN DOTAZIONE

**FG 211**

€/LISTINO  
~~110,00~~

**PROMO**  
**59,90€**



**LAMPADA RICARICABILE A LED**

Led di puntamento superiore  
Regolatore di luminosità  
Orientabile a 360°  
Design sottile del corpo in polipropilene con inserti in gomma antiscivolo  
5 livelli di indicazione dell'autonomia residua  
Base magnetica con gancio estraibile e regolabile in 9 posizioni  
Grado di resistenza ad acqua e polveri IP54  
Caricabatterie in dotazione  
H/mm 385

**MAX 600 LUMEN**



LED DI PUNTAMENTO SUPERIORE



ORIENTABILITÀ A 360°



BASE MAGNETICA E GANCIO ESTRAIBILE

**FG 207**

€/LISTINO  
~~65,00~~

**PROMO**  
**38,90€**



**LAMPADA RICARICABILE A LED**

Led di puntamento superiore  
Pivotante a 180°  
Base magnetica  
Indicatore stato di carica  
Grado di resistenza ad acqua e polveri IP54  
Cavo USB tipo C in dotazione  
H/mm 300

**MAX 300 LUMEN**

CE



LED DI PUNTAMENTO SUPERIORE



GIREVOLE E PIVOTANTE A 180°

**FG 207/B**

€/LISTINO  
~~98,00~~

**PROMO**  
**59,90€**



**LAMPADA RICARICABILE A LED**

Led di puntamento superiore  
Pivotante e girevole a 180°  
3 livelli di indicazione dell'autonomia residua  
Gancio estraibile integrato nella base  
Grado di resistenza ad acqua e polveri IP54  
Grado di resistenza agli urti IK07  
Base magnetica  
Cavo USB tipo C in dotazione  
H/mm 400

**MAX 700 LUMEN**

CE



GIREVOLE FINO A 180°



PIVOTANTE FINO A 180°



SELETORE LUMINOSITÀ 60-700 LUMEN

**FG 212**

€/LISTINO  
~~78,00~~

**PROMO**  
**43,90€**



**LAMPADA RICARICABILE A LED**

Led di puntamento superiore  
Orientabile a 360°  
Base magnetica  
Grado di protezione IP20  
Cavo USB tipo C in dotazione  
H/mm 174

**MAX 200 LUMEN**

CE



LED DI PUNTAMENTO SUPERIORE



ORIENTABILITÀ A 360°

**FG 213/B**

€/LISTINO  
~~140,00~~

PROMO  
**79,00€**

**MAX 1000 LUMEN**

MAX 10h 3h T



**LAMPADA PORTATILE A LED WIRELESS**

Doppio led sul fronte e sul retro da 600/300 lumen e led di puntamento superiore da 120 lumen  
Modalità Full Lighting a tre led accesi per la massima illuminazione dell'ambiente di lavoro con 1000 lumen  
Gancio estraibile girevole sulla base  
Magnete sul retro e sulla base della lampada  
Pivotante a 180°  
3 led di indicazione dello stato di carica  
Base di ricarica magnetica con cavo USB tipo C in dotazione  
Dimensioni: 51.5x42.5x343 mm

**NEW**

343mm



BASE DI RICARICA A INDUZIONE



PIVOTANTE A 180°



MASSIMA LUMINOSITÀ 1000 LUMEN

**FG 201**

€/LISTINO  
~~50,00~~

PROMO  
**29,90€**

**MAX 100 LUMEN**

MAX 6h 2.5h T



**TORCIA TELESCOPICA MAGNETICA RICARICABILE A LED**

Asta telescopica allungabile fino a 505 mm  
Led indicatore dello stato di carica sul pulsante ON/OFF  
Gancio laterale  
Cavo USB tipo C in dotazione  
Dimensioni 21x18x178mm

178mm

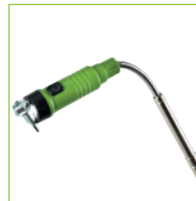

FUNZIONE PICK-UP (1.2 KG DI CAPACITÀ DI CARICO DEL MAGNETE)



GANCIO PER CINTURA



ASTA TELESCOPICA (MAX 505mm)

**FG 213/L480**

€/LISTINO  
~~65,00~~

PROMO  
**39,90€**

**MAX 500 LUMEN**

2.5h MAX 10h

**LAMPADA DA TESTA A DOPPIO LED**

Con sensore on/off contactless  
4 livelli di inclinazione  
Indicatore stato di carica  
4 magneti posteriori per utilizzo senza banda elastica  
Batteria estraibile e possibilità di utilizzo con 3 batterie AAA  
Cavo USB tipo C in dotazione  
Dimensioni 68x39 mm



DOTATA DI 4 MAGNETI POSTERIORI PER L'UTILIZZO SENZA BANDA ELASTICA



4 LIVELLI DI INCLINAZIONE



SENSORE ON/OFF CONTACTLESS

**FG 206**

€/LISTINO  
~~56,00~~

PROMO  
**33,90€**

**MAX 360 LUMEN**

4.5h IP X4 MAX 3h

**LAMPADA RICARICABILE A LED**

Design slim  
Magneti sul retro  
Gancio per appendere la lampada  
Grado di protezione IPX4  
Cavo micro USB in dotazione  
Dimensioni 10x249 mm

249mm



GANCIO SUPERIORE



EXTRA PIATTA

**FG 205/C**

€LISTINO  
~~140,00~~

PROMO  
**69,00€**

**MAX 1000 LUMEN**

**LAMPADA RICARICABILE A LED**

Led di puntamento superiore con luminosità da 60 lumen  
2 ganci estraibili girevoli a 360° sul retro  
2 magneti posteriori + 1 magnete posto sotto la base girevole  
4 led di indicazione dello stato di carica  
Cavo USB tipo C in dotazione  
Funzione power bank (output max USB 5V 1A)  
Funzione dimmer  
Dimensioni 66x39x310

**NEW**

MAX 12h

4.5h



310mm



1 BASE GIREVOLE A 180°



LED DI PUNTAMENTO SUPERIORE 60 LUMEN



2 GANCI ESTRAIBILI GIREVOLI A 360°

**FG 217/B**

€LISTINO  
~~300,00~~

PROMO  
**179,00€**

**MAX 6000 LUMEN**

**LAMPADA RICARICABILE A 3 FARI LED DOTATA DI TREPPIEDI**

Utilizzabile anche collegata al caricabatteria con luminosità da 500 lm  
Potente batteria al litio da 7.3V - 8000mAh  
3 fari led pivotanti (180°) e rotanti (270°)  
4 led di indicazione dello stato di carica  
Funzione Power Bank 5V 1A  
Base magnetica con gancio estraibile integrato  
Altezza totale di 1700 mm (lampada inclusa)  
Sacca in nylon in dotazione  
Cavo USB tipo C in dotazione  
Dimensioni 90x90x205



MAX 8h

10h



3 MAGNETI SULLA BASE



FARI LED PIVOTANTI A 180° E ROTANTI A 270°

205mm



**FG 205/B**

€LISTINO  
~~85,00~~

PROMO  
**49,90€**

**MAX 600 LUMEN**

**LAMPADA RICARICABILE A LED**

Led di puntamento superiore con luminosità da 200 lumen  
Gancio estraibile girevole posizionato sul retro  
Base orientabile a 180° con magnete integrato  
4 led di indicazione dello stato di carica  
Cavo USB tipo C in dotazione  
Dimensioni 54x32x186



MAX 12h

3h

186mm



UN GANCIO ESTRAIBILE GIREVOLE A 360°



BASE MAGNETICA ORIENTABILE FINO A 180°

**TREPPIEDI TELESCOPICO FINO A 1,70 M**



**FG 210/C**

€LISTINO  
~~165,00~~

PROMO  
**99,00€**

**FARETTO DA LAVORO RICARICABILE A LED**

Funzione Power Bank (Output max USB 5V 2A)  
Supporto orientabile a 180°  
5 livelli di indicazione dell'autonomia residua  
Grado di resistenza ad acqua e polveri IP65  
Grado di resistenza agli urti IK07  
Indice di resa cromatica CRI 70+  
Cavo USB tipo C in dotazione  
Dimensioni 208x140 mm

**MAX 3000 LUMEN**

MAX 25h  
6h  
IP 65



SUPPORTO ORIENTABILE 180°



FUNZIONE POWER BANK

**FG 222/A**

€LISTINO  
~~80,00~~

PROMO  
**49,00€**

**LAMPADA RICARICABILE A LED CON CASSE WIRELESS**

LED di puntamento superiore  
Doppia cassa wireless da 5W  
Gancio con magneti integrati, estraibile ed orientabile a 180°  
per appendere o appoggiare la lampada  
Grado di resistenza ad acqua e polveri IP54  
Cavo USB tipo C in dotazione  
Dimensioni 65x164 mm

**MAX 500 LUMEN**

MAX 15h  
4.5h  
IP 54



164mm



LED DI PUNTAMENTO SUPERIORE DA 160 LUMEN



DOPPIA CASSA WIRELESS 5W



GANCIO ESTRAIBILE ED ORIENTABILE FINO A 180°

**FG 210/W**

€LISTINO  
~~70,00~~

PROMO  
**39,90€**

**FARETTO PORTATILE A LED**

Faretto orientabile a 210° con magnete integrato  
Luce spot 250 lumen  
Ricaricabile in 2 modi:  
- con cavo USB tipo C in dotazione in 4h;  
- in modalità wireless in 6h  
3 led di indicazione dello stato di carica  
Dimensioni: 83x35x100 mm

**MAX 670 LUMEN**



BASE MAGNETICA



LUCE SPOT/LUCE SPOT DIFFUSA



FARETTO ORIENTABILE 210°



100mm



MAX 10h  
4h

**FG 222/B**

€LISTINO  
~~290,00~~

PROMO  
**169,00€**

**FARO DA LAVORO RICARICABILE A LED CON CASSE WIRELESS**

Doppia cassa wireless da 10W  
Funzione Power Bank (Output max USB 5V 1A)  
Corpo orientabile a 140°  
Gancio estraibile e girevole integrato nella base  
5 livelli di indicazione dell'autonomia residua  
Grado di resistenza ad acqua e polveri IP65  
Caricabatterie in dotazione  
Dimensioni 210x210 mm

MAX 15h  
3h

**MAX 4000 LUMEN**



210mm



GANCIO ESTRAIBILE E E INTEGRATO



CASSE WIRELESS 10W



CORPO ORIENTABILE A 140°

**FG 221**

€LISTINO  
~~260,00~~

PROMO  
**159,00€**

**FARO DA LAVORO A DOPPIO CORPO ILLUMINANTE**

Rotazione orizzontale di 180° per faro  
Corpo orientabile a 90°  
Batteria al litio estraibile da 14,8V con funzione Power Bank (Output max USB 5V 2A)  
5 livelli di indicazione dell'autonomia residua  
Caricabatteria in dotazione  
Dimensioni 190x295 mm

**MAX 4500 LUMEN**



BATTERIA A LITIO CON FUNZIONE POWER BANK



MAX 12h  
4.5h



295mm



BATTERIA ESTRAIBILE



CORPI ILLUMINANTI ORIENTABILI FINO A 180°

**FG 224/L5200**

€/LISTINO  
~~210,00~~

**PROMO**  
**129,00€**

**FARO DA CANTIERE RICARICABILE A LED CON LENTE ANTIABBLIAMENTO**

Speciale lente opaca che riduce l'effetto abbagliamento ed aumenta la diffusione della luce  
Supporto orientabile a 180° ed agganciabile ai treppiedi  
3 livelli di indicazione dell'autonomia residua  
Grado di resistenza ad acqua e polveri IP65  
Grado di resistenza agli urti IK07  
Caricabatterie in dotazione  
Dimensioni 273x205 mm



**MAX 5200 LUMEN**



MAX 15h  
4h



ORIENTABILE 180°

GRADO DI PROTEZIONE IP65

**FG 224/SU**

TREPPIEDI PER FARO DA CANTIERE FG 224/L5200  
Altezza massima 1,60 M

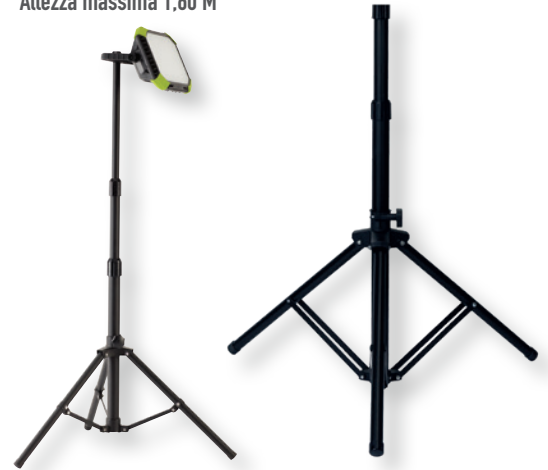

€/LISTINO  
~~80,00~~

**PROMO**  
**49,00€**

MAX 10h  
4.5h



**MAX 1200 LUMEN**

**FG 209**

€/LISTINO  
~~265,00~~

**PROMO**  
**149,00€**

**LAMPADA SOTTOCOFANO RICARICABILE A LED CON LENTE TRASPARENTE E SEMITRASPARENTE**

Lunghezza regolabile fino a 2150mm  
4 livelli di indicazione dell'autonomia residua  
3 tipologie di lente disponibili  
Caricabatteria in dotazione  
Ruotabile a 360°  
Funzione dimmer



BRIGHT MODE (1200 LM)

COMFORTABLE MODE (1100 LM)

SOFT MODE (600 LM)



**FG 210/B**

€/LISTINO  
~~70,00~~

**PROMO**  
**39,90€**

**LAMPADA A TUBO PORTATILE A LED**

Dotata di luce spot superiore  
Sistema di aggancio magnetico  
Modalità luce rossa d'emergenza  
Incluso cavo di ricarica USB tipo C  
Funzione dimmer



486mm

6h  
MAX 15h



**MAX 1200 LUMEN**



LUCE SPOT 400 LUMEN

FUNZIONE POWER BANK

SISTEMA DI AGGANCIO MAGNETICO





# LAMPADE PER CONTROLLO COLORE

## SETTORE CARROZZERIA



**FG 234**

€ LISTINO  
~~105,00~~

**PROMO**  
**59,00€**

☀️ COB LED - cri 96+  
3 COLORI  
2700K 4500K 6500K

🔋 MAX 3h  
🕒 3h  
CE

### LAMPADA DA TESTA LED AD ELEVATO INDICE DI RESA CROMATICA PER CONTROLLO COLORE

Alto indice di resa cromatica CRI 96+  
3 opzioni di temperatura colore 2700K/4500K/ 6500K  
Cavo USB in dotazione  
Dimensioni 50x50 mm



SENSORE ON/OFF CONTACTLESS



4 LIVELLI DI INCLINAZIONE

**MAX 160 LUMEN**

**FG 235**

€ LISTINO  
~~135,00~~

**PROMO**  
**79,00€**

☀️ COB LED - cri 96+  
3 COLORI  
2700K 4500K 6500K

### LAMPADA RICARICABILE A LED AD ELEVATO INDICE DI RESA CROMATICA PER CONTROLLO COLORE

Alto indice di resa cromatica CRI 96+  
3 opzioni di temperatura colore 2700K/4500K/ 6500K  
Grado di resistenza ad acqua e polveri IP65  
Grado di resistenza agli urti IK07  
Base di ricarica da tavolo con presa USB + cavo USB in dotazione  
Dimensioni 50x190 mm



180°



190mm



BASE MAGNETICA + SUPER MAGNETE SUL RETRO



LENTE SOSTITUIBILE



GANCIO ESTRAIBILE

CE  
🕒 4h  
🔋 MAX 4h

**MAX 500 LUMEN**

**FG 236**

€LISTINO  
~~335,00~~

**PROMO**  
**199,00€**

**FARO RICARICABILE A LED AD ELEVATO INDICE DI RESA CROMATICA PER CONTROLLO COLORE**

Alto indice di resa cromatica CRI 96+

5 opzioni di temperatura colore

2700K/3500K/4500K/5500K/6500K

Base pivotante a 180°

Funzione memoria sui parametri dell'ultimo utilizzo

Grado di resistenza ad acqua e polveri IP65

Grado di resistenza agli urti IK07

Accessorio treppiedi non incluso

Dimensioni 115x190 mm

LED - cri 96+  
5 COLORI

2700K 3500K 4500K 5500K 6500K

190mm



PANNELLO DI CONTROLLO



CARICABATTERIE A SGANCIO RAPIDO CON CAVO DA 5 M



CE MAX 8h **MAX 2000 LUMEN**

**FG 236/SU**

€LISTINO  
~~100,00~~

**PROMO**  
**59,00€**

**TREPPIEDI PER FARO LED FG 236**

Altezza 476 mm (chiuso) - 1440 mm (aperto)

Numero di estensioni dei piedi 3

Massimo carico 2 Kg

Peso netto: 1098 gr



476mm



1440mm

**FG 225/SK1.5**

€LISTINO  
~~300,00~~

**PROMO**  
**149,00€**

**AVVOLGICAVO AUTOMATICO 15M 3GX1.5MM<sup>2</sup> CON PRESA SCHUKO**

Lunghezza cavo in ingresso 1,20 M

15m x 3G 1.5mm<sup>2</sup> 1000W

230V AC 2000W



LIMITATORE DI RIENTRO PER ARRESTARE LA CORSA



SISTEMA DI BLOCCAGGIO A QUALSIASI LUNGHEZZA

CE

**FG 225/SK2.5**

€LISTINO  
~~370,00~~

**PROMO**  
**179,00€**

**AVVOLGICAVO AUTOMATICO 15M 3GX2.5MM<sup>2</sup> CON PRESA SCHUKO**

Lunghezza cavo in ingresso 1,20 M

15m x 3G 2.5mm<sup>2</sup> 1600W

230V AC 3200W



STAFFA A MURO ORIENTABILE A 360°

# POWER TOOLS

PRESTAZIONI  
AFFIDABILITA'  
QUALITA'



**BRUSHLESS  
MOTOR**

PRESTAZIONI  
PERFORMANCE



EFFICIENZA  
EFFICIENCY



Scopri la gamma di elettroattrezzi Fasano Tools progettata per soddisfare le esigenze dell'utilizzatore professionale.

Due linee diverse, con batterie al litio rispettivamente con voltaggio 14,4V e 18V, sviluppate per ottimizzare le prestazioni degli utensili, che sfruttano tecnologie di ultima generazione, dotate di celle di elevata

qualità e di innovativi sistemi di gestione e protezione.

Gli utensili a batteria Fasano Tools hanno motore brushless (senza spazzole) e sono forniti in robusta valigetta con manico antiscivolo e clip in metallo, ideale per il pratico riponimento e trasporto degli utensili e della relativa dotazione.

**GAMMA**

# 14.4V

Li-ion  
2Ah

## MANEGGEVOLEZZA E VERSATILITÀ

La piattaforma 14,4V si compone di 7 modelli tutti compatibili con la stessa batteria 14,4V per un'elevata versatilità nelle diverse situazioni d'uso. Grazie al design compatto questi utensili consentono di lavorare con comodità e le loro prestazioni sono adeguate a portare a termine il lavoro nel minor tempo possibile.



**GAMMA**

# 18V

Li-ion  
5Ah

## MASSIME PRESTAZIONI

La piattaforma 18V comprende gli utensili che sono in grado di erogare le prestazioni più elevate per svolgere le applicazioni più gravose. La nuova smerigliatrice angolare da 125 mm a velocità variabile ed il nuovo avvitatore compatto da 1/4" completano la gamma 18V, ampliandone i campi di applicazione.



**GAMMA**

**18V**



**FG 330/LT2**

€/LISTINO  
~~860,00~~

**PROMO**  
**399,00€**

**TRAPANO AVVITATORE CON PERCUSSIONE - 18V**

Motore Brushless

Elevate prestazioni, fino a 135 Nm di coppia massima

Mandrino autoserrante da 13 mm in acciaio

11 posizioni di regolazione della coppia

Doppia velocità

Max percussione: 32000 bpm

Velocità a vuoto 0-550/2000 rpm

Max foratura legno/metallo/muratura: 89/13/16mm

Luce led per illuminare l'area di lavoro

Frizione elettronica

Sistema Anti Kick Back per il massimo controllo dell'utensile

Dotazione: 2 batterie al litio 18V - 5Ah, caricabatteria, gancio

per cintura in metallo, impugnatura laterale, valigetta in ABS

con clip di chiusura in metallo



DIMENSIONI



PRESTAZIONI ELEVATE IN OGNI APPLICAZIONE

**18V** CE

**BRUSHLESS**  
**MOTOR**

LI-ION  
BATTERY

**135**  
Nm  
**MAX**  
TORQUE

**FG 335/LT2**

€/LISTINO  
~~920,00~~

**PROMO**  
**439,00€**

**NEW**

**SMERIGLIATRICE ANGOLARE 125mm - 18V**

Motore Brushless

Velocità regolabile in 5 posizioni tramite apposito selettore

Interruttore a slitta con blocco

Impugnatura laterale orientabile in due posizioni

Cuffia di protezione ad aggancio rapido

Griglie di protezione anti polvere

Dotazione: 2 batterie al litio 18V - 5Ah, caricabatteria, cuffia di

protezione, impugnatura laterale, chiave di servizio, valigetta

in ABS con clip di chiusura in metallo



DIMENSIONI



MANICO AUSILIARIO LATERALE



SELETTORE VELOCITÀ IN 5 POSIZIONI



**18V** CE

**BRUSHLESS**  
**MOTOR**

LI-ION  
BATTERY

**8.000**  
MAX RPM



## FG 305/LT2

€/LISTINO

~~850,00~~

PROMO

**399,00€**

### AVVITATORE A IMPULSI COMPATTO ATTACCO 1/2" - 18V

Motore Brushless

470 Nm di coppia massima in avvitatura e 510 Nm in svitatura

4 modalità di funzionamento ad avvitare

Diametro bullone M10 - M16

Velocità a vuoto 0-2500 rpm

Funzione Tightening Control per il controllo del serraggio

Soft bolt removal mode, previene la caduta del bullone in svitatura

Design compatto

Triplo led per illuminare l'area di lavoro

Dotazione: 2 batterie al litio 18V - 5Ah, caricabatteria, gancio per cintura in metallo, valigetta in ABS con clip di chiusura in metallo



DIMENSIONI



TRIPLO LED

**18V** CE

**1/2"** BRUSHLESS MOTOR



**510 Nm** MAX TORQUE

## FG 310/LT2

€/LISTINO

~~950,00~~

PROMO

**469,00€**

### AVVITATORE A IMPULSI ATTACCO 1/2" - 18V

Motore Brushless

740 Nm di coppia massima in avvitatura e 880 Nm in svitatura

4 modalità di funzionamento ad avvitare

Diametro bullone M16 - M22

Velocità a vuoto 0-2200 rpm

Funzione Tightening Control per il controllo del serraggio

Soft bolt removal mode, previene la caduta del bullone in svitatura

Triplo led per illuminare l'area di lavoro

Dotazione: 2 batterie al litio 18V - 5Ah, caricabatteria, gancio per cintura in metallo, valigetta in ABS con clip di chiusura in metallo



DIMENSIONI



TRIPLO LED

**18V** CE

**1/2"** BRUSHLESS MOTOR



**880 Nm** MAX TORQUE

## FG 315/LT2

€/LISTINO

~~1.050,00~~

PROMO

**529,00€**

### AVVITATORE A IMPULSI AD ALTA COPPIA ATTACCO 1/2" - 18V

Motore Brushless

Elevate prestazioni, fino a 950 Nm di coppia massima in avvitatura e 1800 Nm in svitatura

4 modalità di funzionamento ad avvitare

Diametro bullone M12 - M32

Velocità a vuoto 0-1800 rpm

Funzione Tightening Control per il controllo del serraggio

Soft bolt removal mode, previene la caduta del bullone in svitatura

Triplo led per illuminare l'area di lavoro

Dotazione: 2 batterie al litio 18V - 5Ah, caricabatteria, gancio per cintura in metallo, valigetta in ABS con clip di chiusura in metallo



DIMENSIONI



TRIPLO LED

**18V** CE

**1/2"** BRUSHLESS MOTOR



**1800 Nm** MAX TORQUE

**FG 320/LT2**

€/LISTINO  
~~1.100,00~~

**PROMO**  
**569,00€**

**AVVITATORE A IMPULSI AD ALTA COPPIA ATTACCO 3/4" - 18V**

Motore Brushless  
Elevate prestazioni, fino a 950 Nm di coppia massima in avvitatura e 1800 Nm in svitura  
4 modalità di funzionamento ad avvitare  
Diametro bullone M12 - M32  
Velocità a vuoto 0-1750 rpm  
Funzione Tightening Control per il controllo del serraggio  
Soft bolt removal mode, previene la caduta del bullone in svitura  
Tripla led per illuminare l'area di lavoro  
Dotazione: 2 batterie al litio 18V - 5Ah, caricabatteria, gancio per cintura in metallo, valigetta in ABS con clip di chiusura in metallo



DIMENSIONI



TRIPLO LED

**18V** CE

**3/4"** BRUSHLESS MOTOR

LI-ION BATTERY

**1800 Nm**  
MAX TORQUE

**FG 325/LT2**

€/LISTINO  
~~860,00~~

**PROMO**  
**349,00€**

**NEW**

**AVVITATORE A IMPULSI COMPATTO ATTACCO 1/4" - 18V**

Motore Brushless  
Power control: 3 velocità + 2 modalità dedicate (legno e bulloni) per regolare le prestazioni in base alle applicazioni  
Design compatto  
Attacco esagonale femmina 1/4"  
225 Nm di coppia massima  
Diametro bullone standard M5 - M16  
Velocità a vuoto 0-1900/2800/3600 rpm  
Tripla led per illuminare l'area di lavoro  
Dotazione: 2 batterie al litio 18V - 5Ah, caricabatteria, gancio per cintura in metallo, valigetta in ABS con clip di chiusura in metallo



DIMENSIONI



TRIPLO LED

**18V** CE

**1/4"** BRUSHLESS MOTOR

LI-ION BATTERY

**225 Nm**  
MAX TORQUE



**GAMMA AVVITATORI A IMPULSI 18V**



**FG 325/LT2**

**FG 305/LT2**

**FG 310/LT2**

**FG 315/LT2**

**FG 320/LT2**

	FG 325/LT2	FG 305/LT2	FG 310/LT2	FG 315/LT2	FG 320/LT2
<b>TECNOLOGIA MOTORE</b>	Brushless	Brushless	Brushless	Brushless	Brushless
<b>ATTACCO</b>	Esagonale femmina 1/4"	Quadro maschio 1/2"	Quadro maschio 1/2"	Quadro maschio 1/2"	Quadro maschio 3/4"
<b>BATTERIA</b>	18V - 5Ah	18V - 5Ah	18V - 5Ah	18V - 5Ah	18V - 5Ah
<b>COPPIA MAX AVVITATURA (NM)</b>	225	470	740	950	950
<b>COPPIA MAX SVITATURA (NM)</b>	-	510	880	1800	1800
<b>Ø BULLONE</b>	M5-M16	M10-M16	M16-M22	M12-M32	M12-M32
<b>VELOCITÀ A VUOTO (GIRI/MIN)</b>	0-3600	0-2500	0-2200	0-1800	0-1750
<b>PESO CON BATTERIA (GR)</b>	1.600	1.890	2.360	3.450	3.560



GAMMA

14.4V



FG 360/LT1

€/LISTINO ~~495,00~~

PROMO 259,00€

CRICCHETTO 1/2" - 14,4V

Motore Brushless  
Elevate prestazioni, fino a 95 Nm di coppia massima

Velocità a vuoto 300 Rpm

Testa sottile

Velocità variabile

Luce led per illuminare l'area di lavoro

Dotazione: 1 batteria al litio 14,4V - 2Ah, 1 caricabatteria, valigetta in ABS con clip di chiusura in metallo



DIMENSIONI



TESTA SOTTILE PER LA MASSIMA ACCESSIBILITÀ

14.4V CE

BRUSHLESS MOTOR



FG 363/LT1

€/LISTINO ~~505,00~~

PROMO 269,00€

CRICCHETTO 3/8" - 14,4V

Motore Brushless  
Elevate prestazioni, fino a 95 Nm di coppia massima

Velocità a vuoto 550 Rpm

Design lungo

Velocità variabile

Luce led per illuminare l'area di lavoro

Dotazione: 1 batteria al litio 14,4V - 2Ah, 1 caricabatteria, valigetta in ABS con clip di chiusura in metallo



DIMENSIONI



DESIGN LUNGO PER ACCEDERE AI PUNTI PIÙ DIFFICILI

14.4V CE

BRUSHLESS MOTOR



FG 366/LT1

€/LISTINO ~~525,00~~

PROMO 279,00€

CRICCHETTO 1/4" - 14,4V

Motore Brushless  
Massima efficienza, fino a 61 Nm di coppia massima con una velocità di 500 giri al minuto

Design lungo

Velocità variabile

Luce led per illuminare l'area di lavoro

Dotazione: 1 batteria al litio 14,4V - 2Ah, 1 caricabatteria, valigetta in ABS con clip di chiusura in metallo



DIMENSIONI



DESIGN LUNGO PER ACCEDERE AI PUNTI PIÙ DIFFICILI

14.4V CE

BRUSHLESS MOTOR



**FG 370/LT1**

€/LISTINO  
~~600,00~~

**PROMO**  
**319,00€**

**LEVIGATRICE A NASTRO - 14,4V 10X330MM**

Motore Brushless  
Nastro 10x330 mm  
Velocità variabile  
Velocità a vuoto: 20000 Rpm  
Velocità del nastro: 0~1327 m/min  
Design leggero ed ergonomico  
Luce led per illuminare l'area di lavoro  
Dotazione: 1 batteria al litio 14,4V - 2Ah, 1 caricabatteria,  
valigetta in ABS con clip di chiusura in metallo



DIMENSIONI



BRACCIO GIREVOLE A 360°

**14.4V**

**BRUSHLESS MOTOR**

LI-ION BATTERY

20.000 MAX RPM



**FG 373/LT1**

€/LISTINO  
~~600,00~~

**PROMO**  
**319,00€**

**LEVIGATRICE A NASTRO - 14,4V 20X520MM**

Motore Brushless  
Nastro 20x520 mm  
Velocità variabile  
Velocità a vuoto: 20000 Rpm  
Velocità del nastro: 0~1327 m/min  
Design leggero ed ergonomico  
Luce led per illuminare l'area di lavoro  
Dotazione: 1 batteria al litio 14,4V - 2Ah, 1 caricabatteria,  
valigetta in ABS con clip di chiusura in metallo



DIMENSIONI



BRACCIO GIREVOLE A 360°

**14.4V**

**BRUSHLESS MOTOR**

LI-ION BATTERY

20.000 MAX RPM



**FG 380/LT1**

€/LISTINO  
~~505,00~~

**PROMO**  
**269,00€**

**MINI SMERIGLIATRICE DRITTA 14,4V**

Motore Brushless  
4 velocità  
Velocità a vuoto: 24500 Rpm  
Design compatto  
Testa dritta con attacco a pinza da 6 mm  
Diametro massimo dischi per smeriglio 55 mm  
Luce led per illuminare l'area di lavoro  
Dotazione: 1 batteria al litio 14,4V - 2Ah, 1 caricabatteria,  
valigetta in ABS con clip di chiusura in metallo



DIMENSIONI



PANNELLO DI CONTROLLO VELOCITÀ DI LAVORO

**14.4V**

**BRUSHLESS MOTOR**

LI-ION BATTERY

24.500 MAX RPM



**FG 383/LT1**

€/LISTINO  
~~525,00~~

**PROMO**  
**279,00€**

**MINI SMERIGLIATRICE ANGOLARE 14,4V**

Motore Brushless  
4 velocità  
Velocità a vuoto: 24500 Rpm  
Design compatto  
Testa angolare con attacco a pinza da 6 mm  
Diametro massimo dischi per smeriglio 55 mm  
Luce led inclinabile per illuminare l'area di lavoro  
Dotazione: 1 batteria al litio 14,4V - 2Ah, 1 caricabatteria,  
valigetta in ABS con clip di chiusura in metallo



DIMENSIONI



PANNELLO DI CONTROLLO VELOCITÀ DI LAVORO

**14.4V**

**BRUSHLESS MOTOR**

LI-ION BATTERY

24.500 MAX RPM





## ESTRATTORI



### FG 162/S3

€/LISTINO  
~~366,00~~

PROMO  
**219,00€**

#### SET 3 ESTRATTORI UNIVERSALI A 2 GRIFFE

Presca esterna  
Griffe scorrevoli in acciaio al cromo vanadio

Contenuto:  
A/mm 15-85 - H/mm 100  
A/mm 15-125 - H/mm 100  
A/mm 20-160 - H/mm 150



#### ESTRATTORE UNIVERSALE A 2 GRIFFE SOTTILI

Griffe intercambiabili super sottili da 2mm in acciaio al cromo vanadio  
Presca interna ed esterna  
Vite in acciaio al cromo vanadio

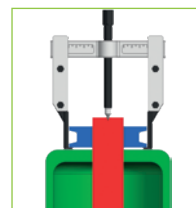

CODICE	A/MM	B/MM	C/MM	€/LISTINO	€/PROMO
FG 168/EF1	110	140	186	340,00	209,00€
FG 168/EF2	195	140	186	350,00	215,00€

#### ESTRATTORE A 3 GRIFFE PER PRESca INTERNA ED ESTERNA

Dotato di 3 griffe per presca interna e 3 griffe per presca esterna  
Griffe in acciaio al cromo vanadio



CODICE	Ø INTERNA	Ø ESTERNA	€/LISTINO	€/PROMO
FG 165/IE1	25-100mm	0-75mm	325,00	199,00€
FG 165/IE2	45-150mm	40-130mm	760,00	459,00€

### FG 163/S2B

€/LISTINO  
~~263,00~~

PROMO  
**159,00€**

#### ESTRATTORE CON GRIFFE PER PRESca INTERNA ED ESTERNA

7 - 140/23 - 130 (per presca esterna)  
40 - 180 (per presca interna)

Griffe autoregolabili in acciaio al cromo vanadio



**MASSA BATTENTE**  
M12x1.5



CODICE	PER	€/LISTINO	€/PROMO
FG 165/MB1	FG 165/IE1	170,00	99,00€
FG 165/MB2	FG 165/IE2	330,00	199,00€

**FG 168SD/S4**

€/LISTINO  
~~162,00~~

**PROMO**  
**99,00€**

**SET 4 SPACCADADI**  
Contenuto: FG 168/SD1 -SD2-SD3-SD4



**SET ESTRATTORI PER DADI DESTORSI DANNEGGIATI CON ATTACCO 1/2"**  
Fornito su supporto in ABS appendibile con ganci a clip e meccanismo finecorsa anticaduta

1/2"



CODICE	CONTENUTO	€/LISTINO	€/PROMO
FG 168A/S5	22, 24, 27, 30, 32 mm	115,00	69,00€
FG 168A/S13	8, 9, 10, 11, 12, 13, 14, 15, 16, 17, 18, 19, 21 mm	220,00	129,00€

**FG 168EP/S5**

€/LISTINO  
~~35,00~~

**PROMO**  
**21,00€**

**SET 5 ESTRATTORI CONICI PER VITI E PRIGIONIERI SPEZZATI**  
Inserimento a percussione



**FG 168/S25**

€/LISTINO  
~~145,00~~

**PROMO**  
**89,00€**

**SET ESTRATTORI PER VITI E PRIGIONIERI SPEZZATI**  
Dotato di guide per interno ed esterno e punte per forare  
Utilizzo: viti/bulloni con diametro 6-16mm

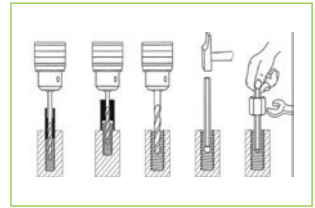

**FG 168/S9**

€/LISTINO  
~~188,00~~

**PROMO**  
**109,00€**

**SET 9 ESTRATTORI A RULLI PER VITI PRIGIONIERE**  
Contenuto: FG 168/R6 - R16



**FG 182/S5B**

€/LISTINO  
~~475,00~~

**PROMO**  
**289,00€**

**SET ESTRATTORI AD ESPANSIONE PER INTERNI CON ACCESSORI**



**FG 182/S14**

€/LISTINO  
~~248,00~~

**PROMO**  
**149,00€**

**SET ESTRATTORI PER CUSCINETTI CON FALSE SFERE**  
Ø/mm 5,6,8,9,11,12,5





## UTENSILI PNEUMATICI



### FGA 307

€/LISTINO  
~~250,00~~

PROMO  
**149,00€**

AVVITATORE AD IMPULSI 1/2"

- 746 Nm MAX
- 610 Nm MAX
- Aria/Air 136 L/min
- 9.500 MAX RPM
- 1200gr
- 6.2 Bar



MARTELLINO SINGOLO

1.085 Nm  
MAX TORQUE



### FGA 307/AN

€/LISTINO  
~~340,00~~

PROMO  
**189,00€**

AVVITATORE ANGOLARE AD IMPULSI 1/2"

- 420 Nm MAX
- 264 Nm MAX
- Aria/Air 113 L/min
- 9.000 MAX RPM
- 1150gr
- 6.2 Bar



MARTELLINO SINGOLO

680 Nm  
MAX TORQUE



### FGA 309

€/LISTINO  
~~300,00~~

PROMO  
**179,00€**

AVVITATORE AD IMPULSI 1/2"

- 1.085 Nm MAX
- 746 Nm MAX
- Aria/Air 151 L/min
- 7.300 MAX RPM
- 1900gr
- 6.2 Bar



MARTELLINO DOPPIO

1.700 Nm  
MAX TORQUE



### FGA 312

€/LISTINO  
~~380,00~~

PROMO  
**199,00€**

AVVITATORE AD IMPULSI 1/2"

- 1130 Nm MAX
- 950 Nm MAX
- Aria/Air 136 L/min
- 7.500 MAX RPM
- 2000gr
- 6.2 Bar



MARTELLINO DOPPIO

2.000 Nm  
MAX TORQUE



**FGA 316**

€/LISTINO  
~~760,00~~

**PROMO**  
**459,00€**

AVVITATORE AD IMPULSI 3/4"

**FGA 316/L**

€/LISTINO  
~~850,00~~

**PROMO**  
**519,00€**

AVVITATORE AD IMPULSI 3/4" AD ALBERO LUNGO 6"



MARTELLO DOPPIO

CE



**FGA 319**

€/LISTINO  
~~1.250,00~~

**PROMO**  
**659,00€**

AVVITATORE AD IMPULSI 1"

**FGA 319/L**

€/LISTINO  
~~1.350,00~~

**PROMO**  
**719,00€**

AVVITATORE AD IMPULSI 1" AD ALBERO LUNGO 6"

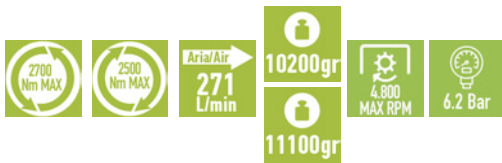

PIN-LESS

CE



**FGA 321**

€/LISTINO  
~~1.130,00~~

**PROMO**  
**589,00€**

AVVITATORE AD IMPULSI 1"

**FGA 321/B**

€/LISTINO  
~~1.220,00~~

**PROMO**  
**649,00€**

AVVITATORE AD IMPULSI 1" AD ALBERO LUNGO 6"



MARTELLO DOPPIO

CE



**FGA 321/C**

€/LISTINO  
~~1.320,00~~

**PROMO**  
**699,00€**

AVVITATORE AD IMPULSI 1" AD ALBERO LUNGO 6"

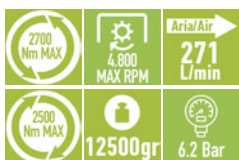

PIN-LESS

CE

**CONSIGLIATO PER UTILIZZI INTENSIVI**





# UTENSILI PNEUMATICI

## FGA 290

€/LISTINO  
~~195,00~~

PROMO  
**119,00€**

**CRICCHETTO REVERSIBILE 1/4"**  
Sistema di reversibilità integrata sulla testa  
Sistema di azionamento a pinza



## FGA 291/D

€/LISTINO  
~~180,00~~

PROMO  
**109,00€**

**MINI CRICCHETTO CON ATTACCO QUADRO 1/4"**



— DIMENSIONI RIDOTTE: SOLO 125MM —



## FGA 292/B

€/LISTINO  
~~215,00~~

PROMO  
**129,00€**

**CRICCHETTO REVERSIBILE 1/2"**



## UTENSILI SEMPRE EFFICIENTI

Per gli utensili pneumatici Fasano Tools sono disponibili a catalogo i kit di manutenzione ordinaria, per ottimizzare il tuo lavoro con utensili sempre ordinati ed efficienti.

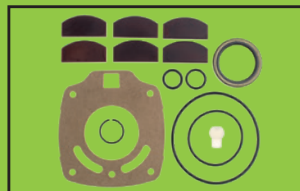
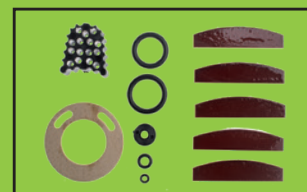
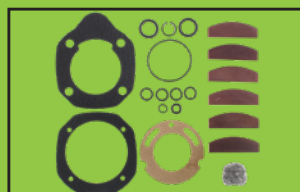

## FGA 322

€/LISTINO  
~~140,00~~

PROMO  
**85,00€**

**LEVIGATRICE PER PNEUMATICI**



## FGA 390

€/LISTINO  
~~162,00~~

PROMO  
**99,00€**

**PISTOLA DI GONFIAGGIO**

Corpo in alluminio nichelato  
Rivestimento in gomma antiolio  
Manometro Ø80 (0-10bar)  
Protezione sovrappressioni  
Leva a due posizioni scarico/gonfiaggio  
Lunghezza tubo: 500 mm





**AVVOLGITUBO**

**FGA 383/AR15**

€/LISTINO  
~~275,00~~

**PROMO**  
**139,00€**

AVVOLGITUBO AUTOMATICO PER ARIA COMPRESSA - 15MT

Ø tubo: 8x12mm

Raccordo in uscita 1/4" maschio

Raccordo in entrata 1/4" maschio

**FGA 385/AR15**

€/LISTINO  
~~360,00~~

**PROMO**  
**179,00€**

AVVOLGITUBO AUTOMATICO PER ARIA COMPRESSA - 15MT

Ø tubo: 10x13mm

Raccordo in uscita 3/8" maschio

Raccordo in entrata 3/8" maschio

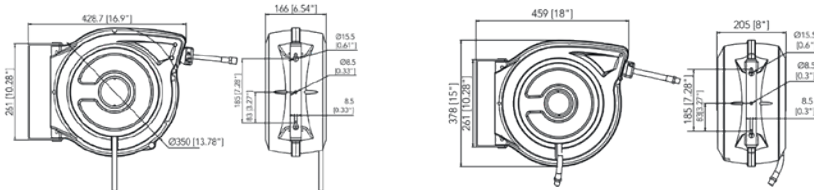

**TUBO IN POLIURETANO RETINATO**  
**STAFFA A MURO ORIENTABILE A 360°**



**Guida di scorrimento automatico**

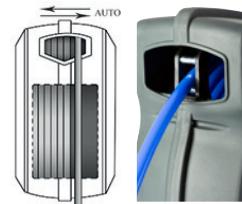

**Sistema di bloccaggio a qualsiasi lunghezza**

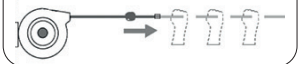

**Riavvolgimento a velocità controllata**

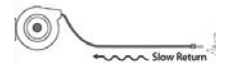

**FGA 419**

€/LISTINO  
~~23,00~~

**PROMO**  
**13,90€**

**PISTOLA DI SOFFIAGGIO**

Valvola ad apertura progressiva

Corpo in alluminio nichelato

Impugnatura in gomma anti-scivolo



**FGA 416**

€/LISTINO  
~~21,00~~

**PROMO**  
**12,90€**

**PISTOLA DI SOFFIAGGIO**

Valvola ad apertura progressiva

Filettatura in ottone





# UTENSILI PNEUMATICI

## LEVIGATRICE ROTO-ORBITALE



152mm	11000 MAX RPM	900gr
45.2 L/min	6.2 Bar	

150mm	11000 MAX RPM	800gr
46 L/min	6.2 Bar	



CODICE		€/LISTINO	€/PROMO
FGA 340	Ø plattello 152mm	295,00	169,00€
FGA 340/B	Ø plattello 150mm	295,00	169,00€

## FGA 342/B

€/LISTINO  
~~285,00~~

PROMO  
**169,00€**

## LEVIGATRICE ROTO-ORBITALE

Ø orbita: 2,5 mm  
Plattello 3 fori in dotazione



75mm	11000 MAX RPM	500gr
46 L/min	6.2 Bar	



## FGA 344

€/LISTINO  
~~250,00~~

PROMO  
**149,00€**

## UTENSILE STACCAVETRI CON LAMA OSCILLANTE

Fornito con una lama da 57mm (FGA 344/LS1)  
Convogliatore dell'aria in uscita

NEW

20.000 MAX RPM
0.50 Hp
1060gr
6.2 Bar



## FGA 342

€/LISTINO  
~~230,00~~

PROMO  
**139,00€**

## LEVIGATRICE ORBITALE

Diametro orbita: 2mm  
3 plattelli in dotazione



74 L/min	13000 MAX RPM	500gr	6.2 Bar
----------	---------------	-------	---------

## FGA 343/N10

€/LISTINO  
~~230,00~~

PROMO  
**139,00€**

## LEVIGATRICE A NASTRO

Dimensione nastro: 10x330mm  
3 nastri in dotazione



0.70 Hp	18000 MAX RPM	90 L/min	800gr	6.2 Bar
---------	---------------	----------	-------	---------

## FGA 343/N20

€/LISTINO  
~~310,00~~

PROMO  
**189,00€**

## LEVIGATRICE A NASTRO

Dimensione nastro: 20x520mm  
3 nastri in dotazione



0.70 Hp	18000 MAX RPM	107 L/min	960gr	6.2 Bar
---------	---------------	-----------	-------	---------

**FGA 337**

€/LISTINO  
~~130,00~~

**PROMO**  
**79,00€**

LEVIGATRICE PNEUMATICA PER RIMOZIONE RESIDUI GOMMOSI



**FGA 330**

€/LISTINO  
~~295,00~~

**PROMO**  
**179,00€**

SEGHETTO ALTERNATIVO

Corpo in alluminio rivestito in gomma antiscivolo  
Protezione lama anteriore in acciaio



**FGA 339**

€/LISTINO  
~~355,00~~

**PROMO**  
**199,00€**

LEVIGATRICE ANGOLARE - Ø DISCO: 115MM

Capacità disco: 115mm  
Sistema di regolazione velocità a pinza

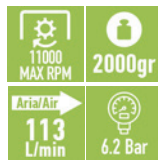

**FGA 332**

€/LISTINO  
~~145,00~~

**PROMO**  
**89,00€**

TRAPANO REVERSIBILE CON MANDRINO AUTOSERRANTE 1-10MM

Mandrino autoserrante 1-10mm (3/8")



**FGA 335**

€/LISTINO  
~~210,00~~

**PROMO**  
**119,00€**

RIVETTATRICE PNEUMATICA

4 testine intercambiabili



**FGA 336**

€/LISTINO  
~~600,00~~

**PROMO**  
**369,00€**

RIVETTATRICE PNEUMATICA

4 testine intercambiabili





## FGA 346/B

€/LISTINO  
~~230,00~~

PROMO  
**139,00€**

MICROSMERIGLIATRICE ASSIALE  
Capacità pinza: 3mm



## FGA 334

€/LISTINO  
~~145,00~~

PROMO  
**89,00€**

SMERIGLIATRICE DIRITTA A PINZA  
Capacità pinza: 6mm



LAME IN KEVLAR



## FGA 338

€/LISTINO  
~~125,00~~

PROMO  
**75,00€**

SMERIGLIATRICE DIRITTA A PINZA  
Corpo in acciaio rivestito in gomma antiscivolo  
Capacità pinza: 6mm



LAME IN KEVLAR



## FGA 334/AN115

€/LISTINO  
~~185,00~~

PROMO  
**109,00€**

SMERIGLIATRICE ANGOLARE A PINZA - INCLINAZIONE 115°  
Capacità pinza: 6mm



LAME IN KEVLAR



## FGA 338/AN

€/LISTINO  
~~170,00~~

PROMO  
**99,00€**

SMERIGLIATRICE ANGOLARE A PINZA  
Corpo in acciaio rivestito in gomma antiscivolo  
Capacità pinza: 6mm



LAME IN KEVLAR



## FGA 334/AN

€/LISTINO  
~~185,00~~

PROMO  
**109,00€**

SMERIGLIATRICE ANGOLARE A PINZA  
Capacità pinza: 6mm



LAME IN KEVLAR



## FGA 338/L

€/LISTINO  
~~165,00~~

PROMO  
**99,00€**

SMERIGLIATRICE PINZA AD ALBERO LUNGO  
Corpo in acciaio rivestito in gomma antiscivolo  
Capacità pinza: 6mm



LAME IN KEVLAR



## FGA 334/L

€/LISTINO  
~~185,00~~

PROMO  
**109,00€**

SMERIGLIATRICE A PINZA AD ALBERO LUNGO  
Capacità pinza: 6mm



LAME IN KEVLAR



# GAMMA AIR COMPACT

Design compatto e prestazioni ottimizzate per lavorare in maniera efficiente, con rapidità e precisione



## FGA 348/A

€/LISTINO  
~~170,00~~

PROMO  
**99,00€**

### SMERIGLIATRICE DIRITTA A PINZA COMPACT

Design leggero e compatto  
Capacità della pinza 6 mm (1/4")  
Attacco aria 1/4" gas  
Ø interno tubo aria 10mm (3/8")

CE NEW



— DIMENSIONI RIDOTTE: SOLO 118MM —

30.000  
MAX RPM

0.30  
Hp

318gr

6.2 Bar

## FGA 348/C

€/LISTINO  
~~250,00~~

PROMO  
**149,00€**

### SMERIGLIATRICE ANGOLARE COMPACT - Ø DISCO 51MM

Design leggero e compatto  
Attacco aria 1/4" gas  
Ø interno tubo aria 10mm (3/8")  
Ø foro del disco da smeriglio da utilizzare: 9.5mm  
In dotazione 1 disco da 2mm e 1 disco da 3mm

CE NEW



— DIMENSIONI RIDOTTE: SOLO 108MM —

22000  
MAX RPM

0.30  
Hp

420gr

6.2 Bar

## FGA 348/B

€/LISTINO  
~~210,00~~

PROMO  
**119,00€**

### SMERIGLIATRICE ANGOLARE A PINZA COMPACT

Design leggero e compatto  
Capacità della pinza 6 mm (1/4")  
Attacco aria 1/4" gas  
Ø interno tubo aria 10mm (3/8")

CE NEW



— DIMENSIONI RIDOTTE: SOLO 121MM —

22000  
MAX RPM

0.30  
Hp

443gr

6.2 Bar

## FGA 348/D

€/LISTINO  
~~280,00~~

PROMO  
**159,00€**

### LEVIGATRICE ORBITALE COMPACT

Design leggero e compatto  
Attacco aria 1/4" gas  
Ø interno tubo aria 10mm (3/8")  
Filettatura 5/16" - 24 UNF  
Ø del platorello 51mm, in dotazione

CE NEW



— DIMENSIONI RIDOTTE: SOLO 108MM —

22000  
MAX RPM

0.30  
Hp

420gr

6.2 Bar

**IL MEGLIO DEL  
MADE IN ITALY**



I nostri carrelli sono frutto di un intenso lavoro di ricerca, sviluppo, progettazione e produzione interna.



**SOLIDITA' E FUNZIONALITA' SONO I TRATTI DISTINTIVI DEI NOSTRI CARRELLI PORTAUTENSILI**

Una gamma completa di modelli che si differenziano per design, colorazioni e funzionalità per offrire all'utilizzatore le migliori soluzioni possibili in base alle sue esigenze

**CASSETTI COMPATIBILI  
CON TUTTI I TERMOFORMATI  
FASANO TOOLS**

**FG 102**



**FG 100**



**FG 122**



**FG 150**



**STANDARD**

DISPONIBILI CON 5-6-7-8 CASSETTI  
IN 5 VARIANTI COLORE + 14 VARIANTI COLORE FG 100 BICOLOR

**FG 104**



**FG 124**



**XL**

DISPONIBILI CON 6-7 CASSETTI  
IN 4 VARIANTI COLORE

**FG 125**



**NEW**

**FG 126**



**NEW**

**FG 162V/14L**



**NEW**

**FG 162V/14P**



**PORTATA  
MASSIMA  
2400Kg**

**CON APPENDICE LATERALE**  
DISPONIBILI IN 4 VARIANTI COLORE

**CON PIANO DI LAVORO UNICO**  
IN LAMIERA D'ACCIAIO DA 2MM CON TOP IN POLICARBONATO  
O IN MULTISTRATO IN PIOPPO DA 18MM  
DISPONIBILI IN 4 VARIANTI COLORE CON 14 CASSETTI

## LA QUALITA' CHE DURA NEL TEMPO

**I CARRELLI FASANO TOOLS  
TI SEMPLIFICANO IL LAVORO:  
SONO REALIZZATI CON LA MASSIMA  
CURA DEI DETTAGLI PER CUSTODIRE  
I TUOI UTENSILI CON AFFIDABILITÀ E PRATICITÀ.**

**IL MANIGLIONE LATERALE IN ACCIAIO  
E LE RUOTE RIVESTITE IN GOMMA VULCANIZZATA  
RENDONO I CARRELLI MANEGGEVOLI  
E FACILMENTE TRASPORTABILI.**

**LA LAMIERA D'ACCIAIO CON SPESSORE 10/10  
GARANTISCE SOLIDITÀ, STABILITÀ E ROBUSTEZZA.**



**I CASSETTI SONO DOTATI DI:  
MANIGLIE IN LAMIERA D'ACCIAIO  
APERTURA AD ESTRAZIONE TOTALE  
GUIDE TELESCOPICHE CON SISTEMA SOFT CLOSING  
TAPPETINI PROTETTIVI ANTIGRAFFIO E ANTISCIVOLO**

**PORTATA DEI CASSETTI:  
45 KG NELLA VERSIONE STANDARD  
60 KG NELLA VERSIONE XL**



## DIVISORI PER CASSETTO

**PREDISPOSIZIONE PER DIVISORI  
INTERNI PER L'ORGANIZZAZIONE  
DELLA MINUTERIA**

**PER ASSICURARE ORDINE  
E PRECISIONE AL TUO LAVORO!**





## CARRELLI PORTA UTENSILI

**OGNI DETTAGLIO  
FA LA DIFFERENZA  
IN TERMINI  
DI SOLIDITA'  
E RESISTENZA  
NEL TEMPO**



TOP SUPERIORE IN GOMMA CON FINITURA CARBON 3D



APERTURA TOTALE DEL CASSETTO CON MECCANISMO SOFT CLOSING



PREDISPOSIZIONE INTERNA PER DIVISORI ADATTI ALLA MINUTERIA



RUOTE RIVESTITE IN GOMMA VULCANIZZATA (2 FISSE + 2 GIREVOLI DI CUI 1 CON FRENO)

## FG 122



### CARRELLO PORTA UTENSILI

Scocca elettrosaldata  
Guide telescopiche con meccanismo soft closing  
Top superiore in gomma con finitura carbon 3D  
Chiusura centralizzata  
Maniglia con spessore 20/10  
Cassetti dotati di tappetini antigraffio e predisposizione per divisori interni  
Apertura totale dei cassetti  
Maniglione laterale in acciaio inox  
Capacità massima dei cassetti: 45kg



**800 Kg**  
**PORTATA STATICA**

CODICE				Cassetti	Peso/Kg	€/listino	€/PROMO
FG 122V/5G	FG 122D/5G	FG 122B/5G	FG 122R/5G	5	65	1.030,00	499,00€
FG 122V/6G	FG 122D/6G	FG 122B/6G	FG 122R/6G	6	69	1.080,00	529,00€
FG 122V/7G	FG 122D/7G	FG 122B/7G	FG 122R/7G	7	71	1.150,00	549,00€

### FG 122/PC

**NEW**

**PORTA PC**  
Per FG 102, FG 104, FG 105, FG 109, FG 122, FG 124, FG 125, FG 126  
Richiudibile



€/LISTINO

~~80,00~~

**PROMO**  
**49,00€**

### FG 122/PL

**NEW**

**PORTA LATTINE**  
Per FG 122, FG 124, FG 125, FG 126

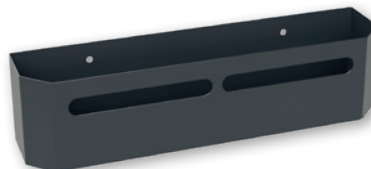

€/LISTINO

~~58,00~~

**PROMO**  
**34,90€**

### FG 100/PR

**PORTA ROTOLO**  
Per FG 100, FG 122, FG 124, FG 125, FG 126



€/LISTINO

~~62,00~~

**PROMO**  
**37,90€**

# FG 124



## CARRELLO PORTA UTENSILI

Scocca elettrosaldata  
Top superiore in gomma con finitura carbon 3D  
Chiusura centralizzata  
Guide telescopiche con meccanismo soft closing  
Cassetti dotati di tappetini antigraffio e predisposizione per divisori interni  
Apertura totale dei cassetti  
Maniglia con spessore 20/10  
Maniglione laterale in acciaio inox  
Capacità massima dei cassetti: 60kg



800 Kg **PORTATA STATICA**

CODICE				Cassetti	Peso/Kg	€/listino	€/PROMO
FG 124V/6G	FG 124D/6G	FG 124B/6G	FG 124R/6G	6	82	1.300,00	619,00€
FG 124V/7G	FG 124D/7G	FG 124B/7G	FG 124R/7G	7	85	1.400,00	659,00€

# FG 125

**NEW**



## CARRELLO PORTA UTENSILI CON APPENDICE LATERALE

Scocca elettrosaldata  
Top superiore in gomma con finitura carbon 3D  
Chiusura centralizzata  
Armadietto laterale con ripiani interni amovibili e anta apribile a 120° dotata di chiusura di sicurezza  
Guide telescopiche con meccanismo soft closing  
Cassetti dotati di tappetini antigraffio e predisposizione per divisori interni  
Apertura totale dei cassetti  
Maniglia con spessore 20/10  
Maniglione laterale in acciaio inox  
Capacità massima dei cassetti: 45kg



800 Kg **PORTATA STATICA**

CODICE				Cassetti	Peso/Kg	€/listino	€/PROMO
FG 125V/5G	FG 125D/5G	FG 125B/5G	FG 125R/5G	5	86	1.460,00	729,00€
FG 125V/6G	FG 125D/6G	FG 125B/6G	FG 125R/6G	6	90	1.510,00	749,00€
FG 125V/7G	FG 125D/7G	FG 125B/7G	FG 125R/7G	7	92	1.580,00	769,00€

# FG 126

**NEW**



## CARRELLO PORTA UTENSILI CON APPENDICE LATERALE

Scocca elettrosaldata  
Top superiore in gomma con finitura carbon 3D  
Armadietto laterale con ripiani interni amovibili e anta apribile a 120° dotata di chiusura di sicurezza  
Guide telescopiche con meccanismo soft closing  
Chiusura centralizzata  
Cassetti dotati di tappetini antigraffio e predisposizione per divisori interni  
Apertura totale dei cassetti  
Maniglia con spessore 20/10  
Maniglione laterale in acciaio inox  
Capacità massima dei cassetti: 60kg



800 Kg **PORTATA STATICA**

CODICE				Cassetti	Peso/Kg	€/listino	€/PROMO
FG 126V/6G	FG 126D/6G	FG 126B/6G	FG 126R/6G	6	103	1.730,00	849,00€
FG 126V/7G	FG 126D/7G	FG 126B/7G	FG 126R/7G	7	106	1.830,00	899,00€



## CARRELLI E BANCHI DA LAVORO

### FG 123



#### CARRELLO PORTA UTENSILI CON PENSILE

Pensile superiore dotato di pistoni a gas  
 Griglia porta utensili  
 Scocca elettrosaldata  
 Top superiore in gomma con finitura carbon 3D  
 Chiusura centralizzata  
 Maniglia con spessore 20/10  
 Cassetti dotati di tappetini antigraffio e predisposizione per divisori interni  
 Guide telescopiche con meccanismo soft closing  
 Apertura totale dei cassetti  
 Maniglione laterale in acciaio inox  
 Ruote rivestite in gomma vulcanizzata Ø125mm  
 (2 fisse e 2 girevoli di cui 1 con freno)  
 Capacità massima dei cassetti: 45kg

NEW



PENSILE SUPERIORE DOTATO DI PISTONI A GAS



GRIGLIA PORTA UTENSILI

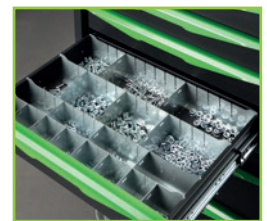

PREDISPOSIZIONE PER DIVISORI INTERNI



800 Kg PORTATA STATICA

CODICE				Cassetti	Peso/Kg	€/listino	€/PROMO
FG 123V/5G	FG 123B/5G	FG 123R/5G	FG 123D/5G	5	81	1.430,00	699,00€
FG 123V/6G	FG 123B/6G	FG 123R/6G	FG 123D/6G	6	85	1.480,00	729,00€
FG 123V/7G	FG 123B/7G	FG 123R/7G	FG 123D/7G	7	87	1.550,00	749,00€

### FG 100



#### CARRELLO PORTA UTENSILI FG 100

Guide telescopiche con meccanismo soft closing  
 4 ruote in gomma vulcanizzata Ø125mm (2 fisse e 2 girevoli, 1 con freno)  
 Chiusura laterale centralizzata  
 Cassetti dotati di tappetini antigraffio  
 Predisposizione per divisori interni  
 Maniglie in acciaio  
 Ripiano superiore in ABS e griglie porta utensili laterali  
 Porta flaconi laterale di serie  
 Pannelli laterali con fori per appendimento ganci porta utensili  
 Capacità massima dei cassetti: 45kg

800 Kg PORTATA STATICA



SISTEMA DI CHIUSURA LATERALE



MANIGLIONE IN ACCIAIO



CASSETTO CON APERTURA COMPLETA



CODICE					Cassetti	Peso/Kg	€/listino	€/PROMO
FG 100V/5T	FG 100B/5T	FG 100R/5T	FG 100D/5T	FG 100W/5T	5	58	1.000,00	519,00€
FG 100V/6T	FG 100B/6T	FG 100R/6T	FG 100D/6T	FG 100W/6T	6	60	1.050,00	549,00€
FG 100V/7T	FG 100B/7T	FG 100R/7T	FG 100D/7T	FG 100W/7T	7	62	1.100,00	569,00€



# FG 162



## CARRELLO PORTA UTENSILI A 14 CASSETTI

Guide telescopiche soft closing  
Maniglione laterale in acciaio  
Porta rotolo e porta lattine in dotazione  
Cassetti dotati di tappetino interno in gomma  
Pannelli laterali con fori per ganci porta utensili  
Ripiano superiore in lamiera da 2mm, con top in policarbonato  
4 ruote rivestite in gomma vulcanizzata Ø160mm  
(2 fisse, 2 girevoli con freno)  
Ante apribili a 110°, dotate di serratura e 2 ripiani interni amovibili  
Griglia laterale portautensili (530x240mm)  
14 cassetti: 5 cassetti 580x398x75mm, 2 cassetti 580x398x135mm, 5 cassetti 580x235x75mm, 2 cassetti 580x235x135mm  
Portata 2400 kg  
Capacità massima dei cassetti: 45kg



**2400 Kg** PORTATA STATICA



CODICE				Cassetti	Peso/kg	€/listino	€/PROMO
FG 162V/14P	FG 162D/14P	FG 162B/14P	FG 162R/14P	14	193	3.300,00	1.699,00€



ANTA APRIBILE A 110°



MANIGLIONE IN ACCIAIO INOX



CASSETTI CON PREDISPOSIZIONE PER

# FG 162

**NEW**



## CARRELLO PORTA UTENSILI A 14 CASSETTI CON TOP IN LEGNO

Guide telescopiche soft closing  
Maniglione laterale in acciaio  
Porta rotolo e porta lattine in dotazione  
Cassetti dotati di tappetino interno in gomma  
Pannelli laterali con fori per ganci porta utensili  
Ripiano superiore in multistrato in pioppo da 18mm  
4 ruote rivestite in gomma vulcanizzata Ø160mm (2 fisse, 2 girevoli con freno)  
Ante apribili a 110°, dotate di serratura e 2 ripiani interni amovibili  
Griglia laterale portautensili (530x240mm)  
14 cassetti: 5 cassetti 580x398x75mm, 2 cassetti 580x398x135mm, 5 cassetti 580x235x75mm, 2 cassetti 580x235x135mm  
Portata 2400kg



**2400 Kg** PORTATA STATICA



CODICE				Cassetti	Peso/kg	€/listino	€/PROMO
FG 162V/14L	FG 162B/14L	FG 162R/14L	FG 162D/14L	14	184	3.300,00	1.699,00€



POSSIBILITÀ DI APPLICARE DIVERSI ACCESSORI



TOP IN MULTISTRATO IN PIOPPO DA 18mm

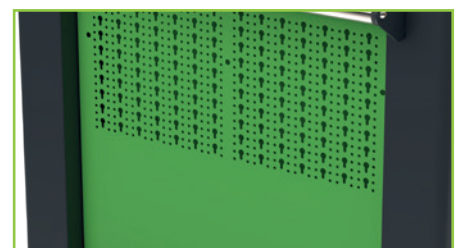

FORI PER GANCI PORTAUTENSILI



# CARRELLI E BANCHI DA LAVORO



## FG 120/CO1V

€/LISTINO  
~~2.600,00~~

PROMO  
**1.199,00€**

### CONFIGURAZIONE MAXI STATION

Ripiano superiore in acciaio (spessore 20/10) con top in policarbonato  
 Verniciatura satinata opaca  
 Maniglione in acciaio inox  
 Cassetti con apertura totale completi di tappetini antigraffio e predisposizione divisori  
 Frontalini copriruota ribaltabili  
 4 ruote girevoli Ø125mm con corpo in polipropilene e rivestite in gomma vulcanizzata (2 con freno)

Composto da:  
 FG 120V/7T - Cassetiera a 7 cassetti  
 FG 120V/A - Modulo armadietto  
 FG 120V/A - Modulo armadietto  
 Dimensioni mm (LxWxH): 1540x460x1030



FG 120/CO1D



FG 120/CO1B



FG 120/CO1R

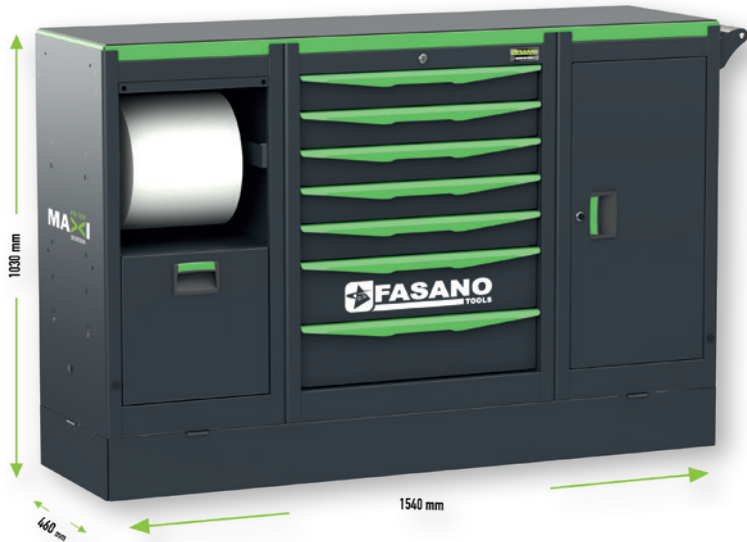

## FG 120/CO2V

€/LISTINO  
~~2.690,00~~

PROMO  
**1.249,00€**

### CONFIGURAZIONE MAXI STATION

Ripiano superiore in acciaio (spessore 20/10) con top in policarbonato  
 Verniciatura satinata opaca  
 Maniglione in acciaio inox  
 Cassetti con apertura totale completi di tappetini antigraffio e predisposizione divisori  
 Frontalini copriruota ribaltabili  
 4 ruote girevoli Ø125mm con corpo in polipropilene e rivestite in gomma vulcanizzata (2 con freno)

Composto da:  
 FG 120V/7T - Cassetiera a 7 cassetti  
 FG 120V/A - Modulo armadietto  
 FG 120V/B - Modulo porta carta con cassetto porta rifiuti  
 Dimensioni mm (LxWxH): 1540x460x1030



FG 120/CO2D



FG 120/CO2B



FG 120/CO2R

**FG 127V/A**

€/LISTINO  
~~570,00~~

**PROMO**  
**299,00€**

**NEW**

**CARRELLO MULTIFUNZIONE**

Struttura in lamiera di acciaio con spessore 20/10  
Maniglie frontali e maniglione posteriore  
per la massima maneggevolezza durante gli spostamenti  
Piano di appoggio inclinato ideale per laptop  
Ripiano laterale porta mouse  
2 ripiani regolabili in altezza  
5 ganci avvolgicavo in lamiera di acciaio  
3 contenitori laterali  
Porta rotolo posteriore  
4 ruote girevoli con rivestimento in gomma antigraffio  
(Ø 75mm, di cui 2 con freno)  
Peso: 25 Kg



5 AVVOLGICAVI LATERALI IN LAMIERA



PIANO DI APPOGGIO INCLINATO CON VANO LATERALE PORTA MOUSE



MANIGLIONE POSTERIORE



**FG 127V/B**

€/LISTINO  
~~680,00~~

**PROMO**  
**359,00€**

**NEW**

**CARRELLO MULTIFUNZIONE CON ANTA DI CHIUSURA**

Struttura in lamiera di acciaio con spessore 20/10  
Maniglie frontali e maniglione posteriore  
per la massima maneggevolezza durante gli spostamenti  
Piano di appoggio inclinato ideale per laptop  
Ripiano laterale porta mouse  
1 ripiano regolabile in altezza ed 1 ripiano fisso  
Vano con anta dotata di chiusura di sicurezza  
5 ganci avvolgicavo in lamiera di acciaio  
3 contenitori laterali  
Porta rotolo posteriore  
4 ruote girevoli con rivestimento in gomma antigraffio  
(Ø 75mm, di cui 2 con freno)  
Peso: 28 Kg



MANIGLIE FRONTALI



VANO CON ANTA DI CHIUSURA



PORTA ROTOLO POSTERIORE



**FG 101V/3G**

€/LISTINO  
~~500,00~~

**PROMO**  
**249,00€**

**CARRELLO PORTA UTENSILI A 3 CASSETTI MOD. FG 101**  
Peso 26,5Kg



2 RIPIANI (SUPERIORE E INFERIORE) PORTA OGGETTI 680X440 MM



POSSIBILITÀ DI INSERIMENTO MODULI DI UTENSILERIA

**FG 108/B**

€/LISTINO  
~~140,00~~

**PROMO**  
**69,00€**

**CARRELLO MULTI-SERVIZIO UNIVERSALE PER MINUTERIE E ATTREZZI DA LAVORO**



DOTATO DI 16 VASCETTE AMOVIBILI PORTA MINUTERIE



STRUTTURA LATERALE IN ALLUMINIO E RIPIANI E ACCESSORI IN ABS



# CARRELLI E BANCHI DA LAVORO

**FG 101D/AS165**

€ LISTINO  
~~1.623,00~~

PROMO  
**699,00€**

CARRELLO PORTA UTENSILI A 6 CASSETTI MOD. FG 101  
CON ASSORTIMENTO 165 UTENSILI IN MODULI RIGIDI

## ASSORTIMENTO 165 UTENSILI



### 1° CASSETTO



- FG 102/03G: Modulo 14 chiavi combinate 6 - 19mm
- FG 102/17E: Modulo 65 utensili da 1/4"
- FG 102/21E: Modulo chiavi a bussola esagonali 1/2" 8-32mm + accessori

### 2° CASSETTO



- FG 102/48G: Modulo 52 inserti - attacco 10mm
- FG 102/VA1: Modulo porta minuterie
- FG 102/65B: Modulo pinza autobloccante e pinza regolabile a cerniera aperta

### 3° CASSETTO



- FG 102/45D: Modulo 6 giraviti a taglio e croce
- FG 102/45I: Modulo 6 giraviti Torx
- FG 102/39D: Modulo 3 pinze



### SISTEMA DI APERTURA A BAIONETTA

**FG 101D/AS196**

€ LISTINO  
**2.127,00**

**PROMO**  
**799,00€**

**CARRELLO PORTA UTENSILI A 7 CASSETTI MOD. FG 101  
CON ASSORTIMENTO 196 UTENSILI IN MODULI RIGIDI**

**ASSORTIMENTO 196 UTENSILI**



**1° CASSETTO**



- FG 102/03G: Modulo 14 chiavi combinate 6 - 19mm
- FG 102/17E: Modulo 65 utensili da 1/4"
- FG 102/21B: Modulo chiavi a bussola esagonali 1/2" 8-32mm + accessori

**2° CASSETTO**



- FG 102/39D: Modulo 3 pinze
- FG 102/45I: Modulo 6 giraviti con impronta Torx
- FG 102/45D: Modulo 6 giraviti a taglio e croce

**3° CASSETTO**



- FG 102/48G: Modulo 52 inserti - attacco 10mm
- FG 102/60D: Modulo utensili per manutenzione
- FG 102/23C: Modulo 14 utensili rinforzati da 1/2"

**4° CASSETTO**



- FG 618/A8, A10, A13, A17, A19: Chiavi a T esagonali snodate





# CARRELLI E BANCHI DA LAVORO

## FG 102V/AS205

€ LISTINO  
~~2.558,00~~

PROMO  
**999,00€**

CARRELLO PORTA UTENSILI A 7 CASSETTI MOD. FG 102  
CON ASSORTIMENTO 205 UTENSILI IN MODULI RIGIDI



### CODICE

FG 102D/AS205

FG 102B/AS205

FG 102R/AS205

FG 102V/AS205

## ASSORTIMENTO 205 UTENSILI

### 1° CASSETTO



- FG 102/03G: Modulo 14 chiavi combinate 6 - 19mm
- FG 102/17: Modulo 11 chiavi a bussola da 1/4" 4-14mm + accessori
- FG 102/21B: Modulo chiavi a bussola esagonali 1/2" 8-32mm + accessori

### 2° CASSETTO



- FG 102/21TX: Modulo 44 utensili Torx
- FG 102/21H: Modulo rigido inserti a bussola 1/2" esagonali e XZN
- FG 102/39D: Modulo 3 pinze

### 3° CASSETTO



- FG 102/45F: Modulo 6 giraviti a croce Phillips
- FG 102/45G: Modulo 7 giraviti a intaglio
- FG 102/48G: Modulo 52 inserti - attacco 10mm

### 4° CASSETTO

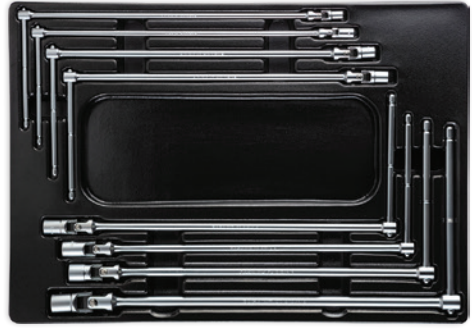

- FG 102/10C: Modulo 8 chiavi a T snodate esagonali 7-19mm



TOP IN GOMMA



**FG 122V/AS170**

€ LISTINO  
**2.805,00**

**PROMO**  
**1.099,00€**

**CARRELLO PORTA UTENSILI A 7 CASSETTI MOD. FG 122  
CON ASSORTIMENTO 170 UTENSILI IN MODULI RIGIDI**

**NEW**



**CODICE**

FG 122V/AS170	FG 122D/AS170	FG 122B/AS170	FG 122R/AS170
---------------	---------------	---------------	---------------

**ASSORTIMENTO 170 UTENSILI**

**1° CASSETTO**



- FG 102/03G: Modulo 14 chiavi combinate 6 - 19mm
- FG 102/03L: Modulo 6 chiavi combinate
- FG 102/51H: Modulo 7 chiavi maschio esagonali

**2° CASSETTO**



- FG 102/17E: Modulo 65 utensili da 1/4"
- FG 102/21B: Modulo chiavi a bussola esagonali 1/2" 8-32mm + accessori
- FG 102/21H: Modulo rigido inserti a bussola 1/2" esagonali e XZN

**3° CASSETTO**



- FG 102/45F: Modulo 6 giraviti a croce Phillips
- FG 102/45G: Modulo 7 giraviti a intaglio
- FG 102/56C: Modulo utensili a percussione

**4° CASSETTO**



- FG 102/42C: Modulo 4 pinze per anelli elastici
- FG 102/39XT: Modulo 3 pinze - serie industrial
- FG 102/65B: Modulo pinza autobloccante e pinza regolabile a cerniera aperta



**4 RUOTE IN GOMMA  
VULCANIZZATA Ø125mm  
(2 FISSE E 2 GIREVOLI  
1 CON FRENO)**





# CARRELLI E BANCHI DA LAVORO

## FG 122V/AS212

€ LISTINO  
~~2.300,00~~

PROMO  
**1.099,00€**

CARRELLO PORTA UTENSILI A 7 CASSETTI MOD. FG 122  
CON ASSORTIMENTO 212 UTENSILI IN MODULI RIGIDI

NEW



### CODICE

FG 122V/AS212	FG 122D/AS212	FG 122B/AS212	FG 122R/AS212
---------------	---------------	---------------	---------------

## ASSORTIMENTO 212 UTENSILI

### 1° CASSETTO



- FG 102/03G: Modulo 14 chiavi combinate 6 - 19mm
- FG 102/03L: Modulo 6 chiavi combinate
- FG 102/21B: Modulo chiavi a bussola esagonali 1/2" 8-32mm + accessori

### 2° CASSETTO



- FG 102/17E: Modulo 65 utensili da 1/4"
- FG 102/19: Modulo utensili con attacco quadro 3/8"
- FG 102/45I: Modulo 6 giraviti con impronta Torx

### 3° CASSETTO



- FG 102/39XT: Modulo 3 pinze - serie industrial
- FG 102/42C: Modulo 4 pinze per anelli elastici
- FG 102/45E: Modulo 8 giraviti ad intaglio e a croce Phillips

### 4° CASSETTO



- FG 102/56C: Modulo utensili a percussione
- FG 102/65B: Modulo pinza autobloccante e pinza regolabile a cerniera aperta
- FG 102/48G: Modulo inserti corti e lunghi con attacco 10mm

CASSETTO  
CON APERTURA  
TOTALE



**FG 100V/AS183**

€/LISTINO  
**2.685,00**

**PROMO**  
**1.199,00€**

**CARRELLO PORTA UTENSILI A 7 CASSETTI MOD. FG 100  
CON ASSORTIMENTO 183 UTENSILI IN MODULI RIGIDI**



**CODICE**

FG 100V/AS183	FG 100B/AS183	FG 100R/AS183	FG 100D/AS183	FG 100W/AS183
---------------	---------------	---------------	---------------	---------------

**ASSORTIMENTO 183 UTENSILI**

**1° CASSETTO**



- FG 102/03G: Modulo 14 chiavi combinate 6 - 19mm
- FG 102/03L: Modulo 6 chiavi combinate
- FG 102/21B: Modulo chiavi a bussola esagonali 1/2" 8-32mm + accessori

**2° CASSETTO**



- FG 102/17: Modulo 11 chiavi a bussola da 1/4" 4-14mm + accessori
- FG 102/48G: modulo inserti corti e lunghi con attacco 10mm
- FG 102/21TX: Modulo 44 utensili con impronta Torx

**3° CASSETTO**



- FG 102/39XT: Modulo 3 pinze - serie Industrial
- FG 102/45D: Modulo 6 giraviti taglio e croce
- FG 102/45I: Modulo 6 giraviti con impronta Torx

**4° CASSETTO**

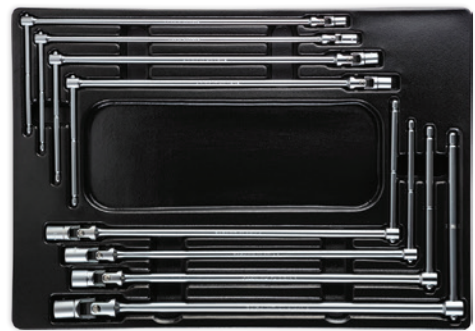

- FG 102/10C: Modulo 8 chiavi a T snodate esagonali 7-19mm



**MANIGLIONE  
INTEGRATO  
IN ACCIAIO**





# CARRELLI E BANCHI DA LAVORO

## FG 100V/AS371

€/LISTINO  
~~3.784,80~~

PROMO  
**1.399,00€**

CARRELLO PORTA UTENSILI A 7 CASSETTI MOD. FG 100  
CON ASSORTIMENTO 371 UTENSILI IN MODULI RIGIDI



### CODICE

FG 100V/AS371	FG 100B/AS371	FG 100R/AS371	FG 100D/AS371	FG 100W/AS371
---------------	---------------	---------------	---------------	---------------

## ASSORTIMENTO 371 UTENSILI

### 1° CASSETTO



- FG 102/03G: Modulo 14 chiavi combinate 6 - 19mm
- FG 102/03L: Modulo 6 chiavi combinate
- FG 102/03E: Modulo 8 chiavi doppia forchetta + FG 139C/FS

### 2° CASSETTO



- FG 102/17E: Modulo 65 utensili da 1/4"
- FG 102/19: Modulo utensili con attacco quadro 3/8"
- FG 102/21B: Modulo chiavi a bussola esagonali 1/2" 8-32mm + accessori

### 3° CASSETTO



- FG 102/21TX: Modulo 44 utensili con impronta Torx
- FG 102/21H: Modulo rigido inserti a bussola 1/2" esagonali e XZN
- FG 102/21R: Modulo inserti a bussola ribe con attacco 1/2"

### 4° CASSETTO



- FG 102/56C: Modulo utensili da percussione
- FG 102/39XT: Modulo 3 pinze - serie Industrial
- FG 102/42C: Modulo 4 pinze per anelli elastici

### 5° CASSETTO



- FG 102/45G: Modulo 7 giraviti ad taglio
- FG 102/45F: Modulo 6 giraviti a croce Phillips
- FG 102/45I: Modulo 6 giraviti con impronta Torx

### 6° CASSETTO



- FG 102/48G: Modulo 52 inserti - attacco 10mm
- FG 102/65B: Modulo pinza autobloccante e pinza regolabile a cerniera aperta
- FG 102/23C: Modulo 14 utensili rinforzati da 1/2"
- FG 85/S31: Set 30 inserti + porta inserti

**FG 124V/AS257**

€ LISTINO  
**3.448,00**

**PROMO**  
**1.499,00€**

**CARRELLO PORTA UTENSILI A 7 CASSETTI MOD. FG 124  
CON ASSORTIMENTO 257 UTENSILI IN MODULI RIGIDI**

**NEW**



**CODICE**

FG 124V/AS257	FG 124D/AS257	FG 124B/AS257	FG 124R/AS257
---------------	---------------	---------------	---------------

**ASSORTIMENTO 257 UTENSILI**

**1° CASSETTO**



- FG 102/03H: Modulo rigido 18 chiavi combinate
- FG 102/03E: Modulo rigido 8 chiavi a doppia forchetta + FG 139C/FS
- FG 102/07C: Modulo 7 chiavi doppie poligonali

**2° CASSETTO**



- FG 102/17E: Modulo 65 utensili da 1/4"
- FG 102/21TX: Modulo 44 utensili con impronta Torx
- FG 102/21B: Modulo chiavi a bussola esagonali 1/2" 8-32mm + accessori
- FG 102/48G: Modulo 52 inserti - attacco 10mm

**3° CASSETTO**



- FG 102/42C: Modulo 4 pinze per anelli elastici
- FG 102/39XT: Modulo 3 pinze - serie Industrial
- FG 102/45D: Modulo 6 giraviti taglio e croce
- FG 102/45I: Modulo 6 giraviti con impronta Torx

**4° CASSETTO**



- FG 102/65B: Modulo pinza autobloccante e pinza regolabile a cerniera aperta
- FG 102/10C: Modulo 8 chiavi a T snodate esagonali 7-19mm

**MANIGLIA  
IN ACCIAIO 20/10**





# CARRELLI E BANCHI DA LAVORO

## FG 102/03G

€/LISTINO  
~~140,00~~

PROMO  
**85,00€**

MODULO 14 CHIAVI COMBinate IN MM  
FG 600/B6,7,8,9,10,11,12,13, 14,15,16,17,18,19mm

1/3



## FG 102/07C

€/LISTINO  
~~92,00~~

PROMO  
**59,90€**

MODULO 7 CHIAVI DOPPIE POLIGONALI  
FG 615/B6x7, 8x9, 10x11,12x13, 14x15, 16x17, 18x19mm

1/3



## FG 102/03L

€/LISTINO  
~~145,00~~

PROMO  
**89,00€**

MODULO 6 CHIAVI COMBinate  
FG 600/B21, 22, 24, 27, 30, 32 mm

1/3



## FG 102/07D

€/LISTINO  
~~138,00~~

PROMO  
**83,90€**

MODULO 5 CHIAVI DOPPIE POLIGONALI  
FG 615/B20x22, 21x23, 24x27, 25x28, 30x32mm

1/3

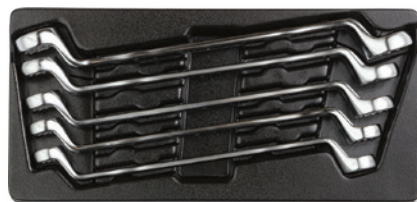

## FG 102/03H

€/LISTINO  
~~250,00~~

PROMO  
**149,00€**

MODULO 18 CHIAVI COMBinate IN MM  
FG 600/B6,7,8,10,11,12,13,14,16,17,18,19, 21, 22, 24, 27, 30, 32mm

2/3



## FG 102/08C

€/LISTINO  
~~245,00~~

PROMO  
**149,00€**

MODULO 11 CHIAVI A CRICCO REVERSIBILE  
FG 605/B8, 10, 11, 12, 13, 14, 15, 16, 17, 18, 19mm

1/3



## FG 102/10C

€/LISTINO  
~~340,00~~

PROMO  
**209,00€**

MODULO 8 CHIAVI A T SNODATE  
FG 618/A7, 8, 10, 11, 13, 14, 17, 19 mm

1/1

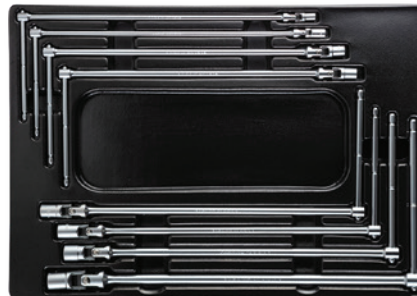

## FG 102/03E

€/LISTINO  
~~85,00~~

PROMO  
**51,90€**

MODULO 8 CHIAVI DOPPIA FORCHETTA  
FG 602/B6x7, 8x9, 10x11, 12x13, 14x15, 16x17, 18x19, 20x22 mm + FG 139C/FS

1/3



## FG 102/03F

€/LISTINO  
~~100,00~~

PROMO  
**59,90€**

MODULO 5 CHIAVI DOPPIA FORCHETTA  
FG 602/B21x23, 24x26, 25x28, 27x29, 30x32 mm

1/3



## FG 102/13C

€/LISTINO  
~~185,00~~

PROMO  
**115,00€**

MODULO 10 CHIAVI A PIPA 6X12PT  
FG 613/A6,7,8,10,11,12,13,14,17,19mm

1/3

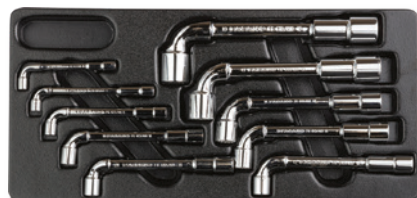

**FG 102/17**

€/LISTINO  
~~135,00~~

**PROMO**  
**79,90€**

**MODULO CHIAVI A BUSSOLA ESAGONALI**

FG 615/B6x7, 8x9, 10x11, 12x13, 14x15, 16x17, 18x19mm



**MODULO CHIAVI A BUSSOLA**  
10-32mm

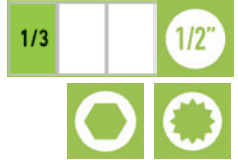

CODICE	ATTACCO	€/LISTINO	€/PROMO
FG 102/21E	Esagonale	170,00€	99,00€
FG 102/21D	Poligonale	170,00€	99,00€

**FG 102/17E**

€/LISTINO  
~~275,00~~

**PROMO**  
**169,00€**

**MODULO CHIAVI A BUSSOLA ESAGONALI**

FG 605/B8, 10, 11, 12, 13, 14, 15, 16, 17, 18, 19mm



**FG 102/21TX**

€/LISTINO  
~~245,00~~

**PROMO**  
**149,00€**

**MODULO UTENSILI CON IMPRONTA TORX**



**FG 102/19**

€/LISTINO  
~~200,00~~

**PROMO**  
**119,00€**

**MODULO CHIAVI A BUSSOLA ESAGONALI**

8-23mm Esagonali



**FG 102/21H**

€/LISTINO  
~~210,00~~

**PROMO**  
**129,00€**

**MODULO INSERTI A BUSSOLA**

FG 150/H2-H8, FG 150L/H2-H8, FG 150/M5-M16, FG 150L/M5-M16



**FG 102/19B**

€/LISTINO  
~~200,00~~

**PROMO**  
**119,00€**

**MODULO CHIAVI A BUSSOLA POLIGONALI**

8- 23mm Poligonali



**FG 102/21R**

€/LISTINO  
~~230,00~~

**PROMO**  
**139,00€**

**MODULO INSERTI A BUSSOLA RIBE**

FG 150/R4-R14, FG 150L/R4-R14, FG 150/R4-R14, FG 150L/R4-R14

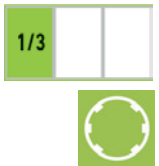

**MODULO CHIAVI A BUSSOLA**

10-32mm



**MODULO CHIAVI A BUSSOLA ESAGONALI**  
34-50mm



CODICE	ATTACCO	€/LISTINO	€/PROMO
FG 102/21B	Esagonale	245,00€	149,00€
FG 102/21C	Poligonale	255,00€	149,00€

CODICE	ATTACCO	€/LISTINO	€/PROMO
FG 102/25	Esagonale	395,00€	239,00€
FG 102/25B	Poligonale	395,00€	239,00€



# CARRELLI E BANCHI DA LAVORO

## FG 102/23C

€/LISTINO

~~145,50~~

PROMO  
**89,00€**

MODULO 13 CHIAVI A BUSSOLA RINFORZATE  
FG 628/C10,11,12,13,14,16,17,18,19,21,22,23,24mm  
+ FG 628/PR125



1/3

1/2"



## FG 102/45D

€/LISTINO

~~47,00~~

PROMO  
**28,90€**

MODULO 6 GIRAVITI TAGLIO E CROCE  
FG 22/3x100, 4x125, 5.5x150, 6.5x150,  
FG 22/PH1x80, PH2x150



1/3



## FG 102/51H

€/LISTINO

~~130,00~~

PROMO  
**79,90€**

MODULO 7 CHIAVI MASCHIO ESAGONALI  
FG 621/H2, 2.5, 3, 4, 5, 6, 8mm



1/3



## FG 102/45E

€/LISTINO

~~57,00~~

PROMO  
**34,90€**

MODULO 8 GIRAVITI TAGLIO E CROCE  
3x100, 4x125, 5.5x150, 6.5x150, 6.5x38,  
PH1x80, PH2x150, PH2x38



1/3



## FG 102/39XT

€/LISTINO

~~102,00~~

PROMO  
**59,90€**

MODULO 3 PINZE - SERIE INDUSTRIAL  
FG 59/XT180 - FG 61/XT160 - FG 63/XT160



1/3

## FG 102/45F

€/LISTINO

~~54,00~~

PROMO  
**32,90€**

MODULO 6 GIRAVITI A CROCE PHILLIPS  
PH0x60, PH1x150, PH2x100, PH2x150, PH3x150, PH2x38



1/3



## FG 102/39D

€/LISTINO

~~75,00~~

PROMO  
**45,90€**

MODULO 3 PINZE  
FG 59PV/180, FG 61PV/160, FG 63PV/160



1/3

## FG 102/45G

€/LISTINO

~~54,00~~

PROMO  
**32,90€**

MODULO 7 GIRAVITI A TAGLIO  
2.5x60, 3x100, 3.5x100, 4x125, 5.5x150, 5.5x100, 6.5x150



1/3



MODULO 4 PINZE PER ANELLI ELASTICI INTERNI ED ESTERNI



1/3

## FG 102/45U

€/LISTINO

~~92,00~~

PROMO  
**59,90€**

MODULO 12 GIRAVITI TAGLIO E CROCE



2/3



CODICE	CAPACITÀ	€/LISTINO	€/PROMO
FG 102/41C	8-25mm	98,00€	59,90€
FG 102/42C	19-60mm	110,00€	65,00€

**MODULO 6 GIRAVITI CON IMPRONTA TORX**  
TX10, TX15, TX20, TX25, TX27, TX30



1/3  

CODICE	ATTACCO	€/LISTINO	€/PROMO
FG 102/45I	Torx	66,00€	39,90€
FG 102/45L	Torx forato	67,00€	39,90€

**FG 102/56C**

€/LISTINO  
~~125,00~~

**PROMO**  
**76,90€**

**MODULO UTENSILI DA PERCUSSIONE**  
FG 132/500, FG 136/40, FG 126/SN1, FG 126/SN3



1/3 

**FG 102/60D**

€/LISTINO  
~~51,00~~

**PROMO**  
**29,90€**

**MODULO UTENSILI PER MANUTENZIONE**  
FG 44/MT5, FG 50/AR, FG 48/LG, FG 79/SP4, FG 497/OP1



1/3 

**FG 102/45T**

€/LISTINO  
~~78,00~~

**PROMO**  
**45,90€**

**MODULO 6 GIRAVITI A BUSSOLA ESAGONALE**  
FG 22/FX6, FX7, FX8, FX10, FX13



1/3 

**FG 102/48G**

€/LISTINO  
~~120,00~~

**PROMO**  
**72,90€**

**MODULO 52 INSERTI - ATTACCO 10MM**



1/3  

**FG 102/62B**

€/LISTINO  
~~95,00~~

**PROMO**  
**57,90€**

**MODULO LIME A TAGLIO MEZZODOLCE**  
FG 80/8AR, FG 80/8AM, FG 80/8AP, FG 80/8AT, FG 80/8AQ



1/3 

**FG 102/50F**

€/LISTINO  
~~76,00~~

**PROMO**  
**45,90€**

**MODULO 6 CHIAVI MASCHIO ESAGONALI**  
FG 142/2, 2.5, 3, 4, 5, 6



1/3 

**FG 102/65B**

€/LISTINO  
~~65,00~~

**PROMO**  
**39,90€**

**MODULO PINZE AUTOBLOCCANTI**  
FG 58/B240, FG 69/CJ250



1/3 

**FG 102/50G**

€/LISTINO  
~~76,00~~

**PROMO**  
**45,90€**

**MODULO 6 CHIAVI MASCHIO TORX**  
FG 143/TX10, TX15, TX20, TX25, TX27, TX30



1/3 

**FG 102/VA1**

€/LISTINO  
~~15,00~~

**PROMO**  
**8,90€**

**MODULO VUOTO PORTA MINUTERIE**



1/3 



# CARRELLI E BANCHI DA LAVORO

## FG 122V/AS217

€/LISTINO  
**2.597,50**

**PROMO**  
**1.099,00€**

CARRELLO PORTA UTENSILI FG 122 A 6 CASSETTI  
CON ASSORTIMENTO 217 UTENSILI IN MODULI DI GOMMA



### CODICE

FG 122V/AS217	FG 122D/AS217	FG 122B/AS217	FG 122R/AS217
---------------	---------------	---------------	---------------

## ASSORTIMENTO 217 UTENSILI

### 1° CASSETTO

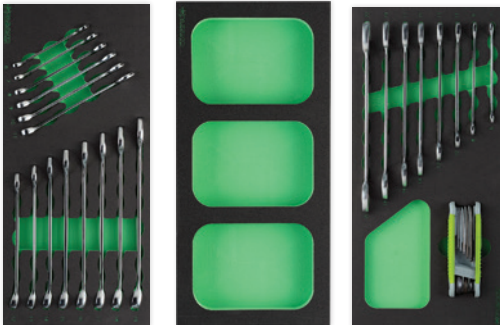

- FG 100/03G: Modulo 14 chiavi combinate 6 - 19mm
- FG 100/VA1: Modulo porta minuterie
- FG 100/03E: Modulo 8 chiavi a forchetta + set 9 chiavi maschio esagonali

### 2° CASSETTO



- FG 100/17: Modulo utensili con attacco quadro 1/4"
- FG 100/19: Modulo utensili con attacco quadro 3/8"
- FG 100/21B: Modulo utensili con attacco quadro 1/2"

### 3° CASSETTO



- FG 100/39XT: Modulo 3 pinze assortite - serie industrial
- FG 100/48E: Modulo 98 inserti con attacco 1/4" e 2 porta inserti
- FG 100/65B: Modulo pinze autobloccanti

### 4° CASSETTO

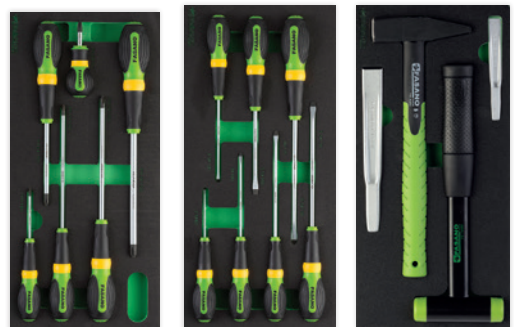

- FG 100/45F: Modulo 6 giraviti a croce Phillips
- FG 100/45G: Modulo 7 giraviti con testa ad intaglio
- FG 100/56C: Modulo utensili da percussione



**TOP SUPERIORE IN GOMMA  
CON FINITURA CARBON 3D**



**FG 100V/AS224**

€/LISTINO  
**2.878,00**

**PROMO**  
**1.199,00€**

**CARRELLO PORTA UTENSILI FG 100 A 7 CASSETTI  
CON ASSORTIMENTO 224 UTENSILI IN MODULI DI GOMMA**



**CODICE**

FG 100V/AS224	FG 100B/AS224	FG 100R/AS224	FG 100D/AS224	FG 100W/AS224
---------------	---------------	---------------	---------------	---------------

**ASSORTIMENTO 224 UTENSILI**

**1° CASSETTO**



- FG 100/03G: Modulo 14 chiavi combinate 6 - 19mm
- FG 100/17E: Modulo 65 utensili da 1/4"
- FG 100/21B: Modulo chiavi a bussola esagonali 1/2" 8-32mm + accessori

**2° CASSETTO**



- FG 100/39XT: Modulo 3 pinze assortite - serie industrial
- FG 100/VA1: Modulo porta minuterie
- FG 100/21TX: Modulo utensili torx con attacco 1/4" e 1/2"

**3° CASSETTO**



- FG 100/45I: Modulo 6 giraviti con impronta torx
- FG 100/45D: Modulo 6 giraviti a taglio e croce
- FG 100/48G: Modulo inserti corti e lunghi con attacco 10mm

**4° CASSETTO**

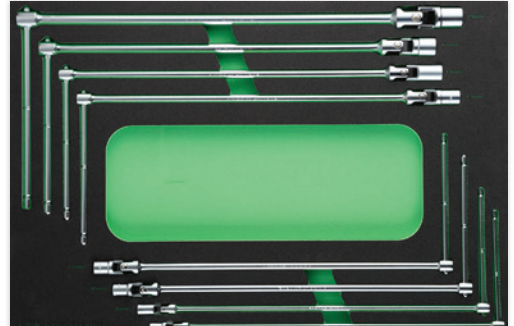

- FG 100/10C: Modulo 8 chiavi a T snodate 7-19mm



**RIPIANO SUPERIORE  
IN ABS**





# CARRELLI E BANCHI DA LAVORO

## FG 122V/AS413

€/LISTINO  
~~4.862,80~~

PROMO  
**1.399,00€**

CARRELLO PORTA UTENSILI FG 122 A 7 CASSETTI  
CON ASSORTIMENTO 413 UTENSILI IN MODULI DI GOMMA



CODICE

FG 122V/AS413

FG 122D/AS413

FG 122B/AS413

FG 122R/AS413

## ASSORTIMENTO 413 UTENSILI

1° CASSETTO

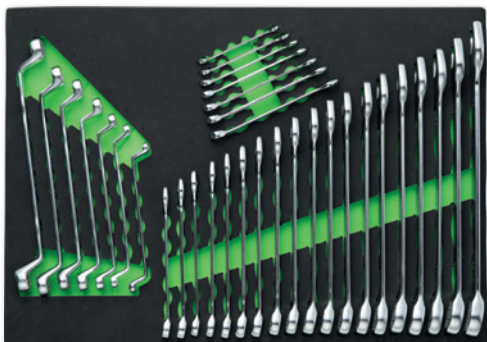

FG 100/03M: Modulo chiavi combinate poligonali e poligonali doppie curve

2° CASSETTO



-FG 100/21F: Modulo chiavi a bussola esagonali, inserti e accessori 1/4", 3/8", 1/2"

3° CASSETTO



-FG 100/81G: Modulo inserti e chiavi a bussola 1/4" e 1/2"

4° CASSETTO

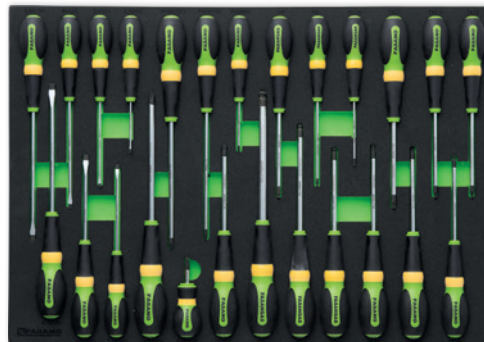

-FG 100/45R: Modulo giraviti impronte a intaglio, Phillips, esagonali sferiche e Torx

5° CASSETTO



-FG 100/39E: Modulo pinze e inserti

MODULI IN GOMMA  
A PIENO CASSETTO



**FG 100V/AS230**

€/LISTINO  
~~3.571,50~~

**PROMO**  
**1.399,00€**

**CARRELLO PORTA UTENSILI FG 100 A 7 CASSETTI  
CON ASSORTIMENTO 230 UTENSILI IN MODULI IN GOMMA**



**CODICE**

FG 100V/AS230	FG 100B/AS230	FG 100R/AS230	FG 100D/AS230	FG 100W/AS230
---------------	---------------	---------------	---------------	---------------

**ASSORTIMENTO 230 UTENSILI**

**1° CASSETTO**



- FG 100/03G: Modulo 14 chiavi combinate 6 - 19mm
- FG 100/03L: Modulo 6 chiavi combinate
- FG 100/03E: Modulo 8 chiavi a forchetta + set 9 chiavi maschio esagonali

**2° CASSETTO**

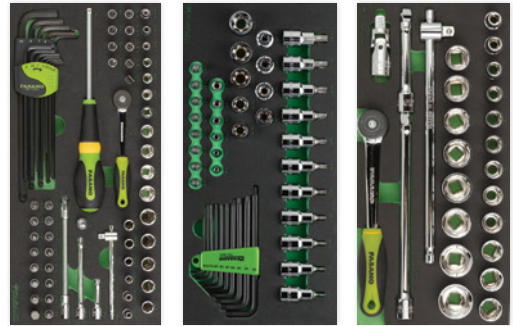

- FG 100/17E: Modulo 65 utensili da 1/4"
- FG 100/21TX: Modulo utensili torx con attacco 1/4" e 1/2"
- FG 100/21B: Modulo chiavi a bussola esagonali 1/2" 8-32mm + accessori

**3° CASSETTO**



- FG 100/81F: Modulo inserti a bussola con attacco quadro 1/2"
- FG 100/65B: Modulo pinze autobloccanti
- FG 100/42C: Modulo 4 pinze per anelli elastici 19-60mm

**4° CASSETTO**



- FG 100/39XT: Modulo 3 pinze assortite - serie industrial
- FG 100/45D: Modulo 6 giraviti a taglio e croce
- FG 100/45I: Modulo 6 giraviti con impronta torx

**5° CASSETTO**



- FG 100/10D: Modulo 12 chiavi a T snodate esagonali



## FG 122V/AS402

€/LISTINO  
~~4.819,40~~

PROMO  
**1.499,00€**

CARRELLO PORTA UTENSILI FG 122 A 7 CASSETTI  
CON ASSORTIMENTO 402 UTENSILI IN MODULI DI GOMMA



### CODICE

FG 122V/AS402	FG 122D/AS402	FG 122B/AS402	FG 122R/AS402
---------------	---------------	---------------	---------------

## ASSORTIMENTO 402 UTENSILI

### 1° CASSETTO

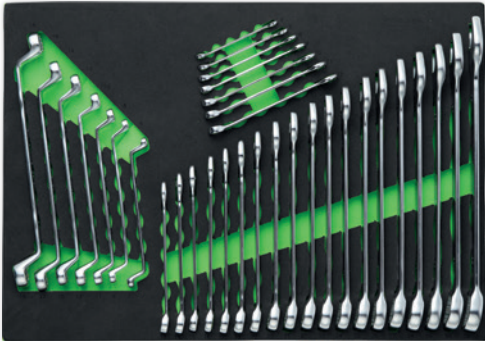

FG 100/03M: Modulo chiavi combinate poligonali e poligonali doppie curve

### 2° CASSETTO



-FG 100/21F: Modulo chiavi a bussola esagonali, inserti e accessori 1/4", 3/8", 1/2"

### 3° CASSETTO



-FG 100/81G: Modulo inserti e chiavi a bussola 1/4" e 1/2"

### 4° CASSETTO



-FG 100/39F: Modulo giraviti, pinze e inserti

### 5° CASSETTO

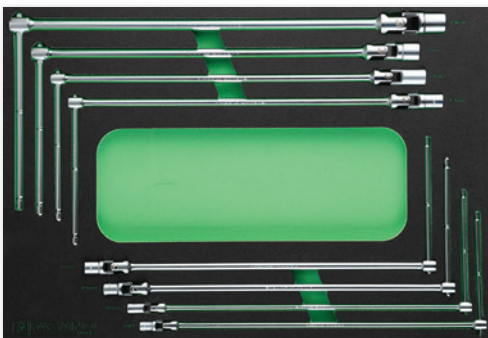

- FG 100/10C: Modulo 8 chiavi a T snodate 7-19m

 **FASANO**  
TOOLS

**FG 100VD/AS355**

€/LISTINO  
~~4.293,80~~

**PROMO**  
**1.599,00€**

**CARRELLO BI-COLOR PORTA UTENSILI FG 100 A 7 CASSETTI  
CON ASSORTIMENTO 355 UTENSILI IN MODULI IN GOMMA**



FG 100VD/AS355 FG 100VW/AS355 FG 100BW/AS355 FG 100RY/AS355 FG 100CW/AS355 FG 100MA/AS355 FG 100RB/AS355



FG 100DP/AS355 FG 100DW/AS355 FG 100BY/AS355 FG 100BD/AS355 FG 100RD/AS355 FG 100GW/AS355 FG 100RW/AS355



**ASSORTIMENTO 355 UTENSILI**

**1° CASSETTO**

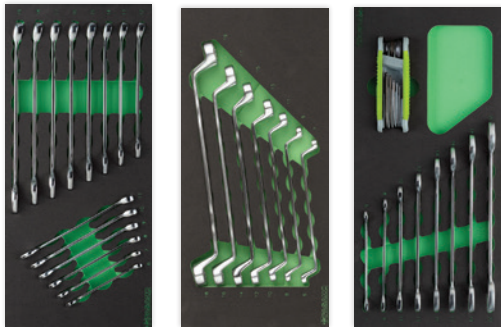

- FG 100/03G: Modulo 14 chiavi combinate 6 - 19mm
- FG 100/07C: Modulo 7 chiavi doppie poligonali
- FG 100/03E: Modulo 8 chiavi a forchetta + set 9 chiavi maschio esagonali

**2° CASSETTO**



- FG 100/17E: Modulo 65 utensili da 1/4"
- FG 100/19: Modulo chiavi a bussola esagonali
- FG 100/21B: Modulo chiavi a bussola esagonali 1/2" 8-32mm + accessori

**3° CASSETTO**



- FG 100/21TX: Modulo utensili torx con attacco 1/4" e 1/2"
- FG 100/81F: Modulo inserti a bussola esagonale e XZN
- FG 100/82B: Modulo inserti a bussola ribe con attacco 1/2"

**4° CASSETTO**

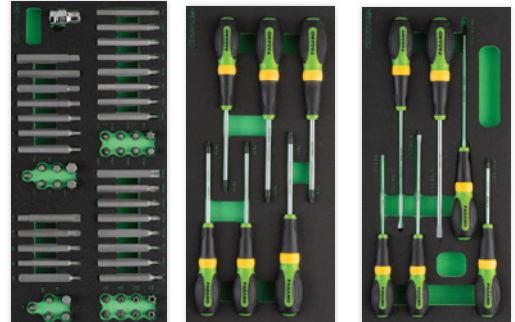

- FG 100/48G: Modulo inserti con attacco mm
- FG 100/45I: Modulo 6 giraviti Torx
- FG 100/45D: Modulo 6 giraviti a taglio e croce Phillips

**5° CASSETTO**



- FG 100/65B: Modulo 2 pinze
- FG 100/39XT: Modulo 3 pinze assortite -serie industrial
- FG 100/42C: Modulo 4 pinze per anelli elastici 19-60mm

**6° CASSETTO**

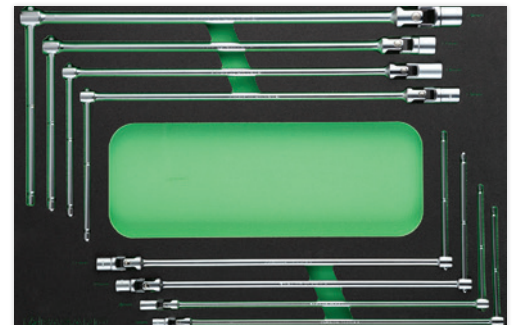

- FG 100/10C: Modulo 8 chiavi a T snodate 7-19m
- FG 85/S31: Set 30 inserti + porta inserti



# CARRELLI E BANCHI DA LAVORO

## FG 124V/AS322

€ LISTINO  
~~3.926,50~~

PROMO  
**1.599,00€**

CARRELLO PORTA UTENSILI FG 124 A 7 CASSETTI  
CON ASSORTIMENTO 322 UTENSILI IN MODULI DI GOMMA



### CODICE

FG 124V/AS322	FG 124D/AS322	FG 124B/AS322	FG 124R/AS322
---------------	---------------	---------------	---------------

## ASSORTIMENTO 322 UTENSILI

### 1° CASSETTO



- FG 100/03G: Modulo 14 chiavi combinate 6 - 19mm
- FG 100/03L: Modulo 6 chiavi combinate 21, 22, 24, 27, 30, 32 mm
- FG 100/VA4: Modulo porta minuteria
- FG 100/21H: Modulo chiavi a bussola esagonali

### 2° CASSETTO

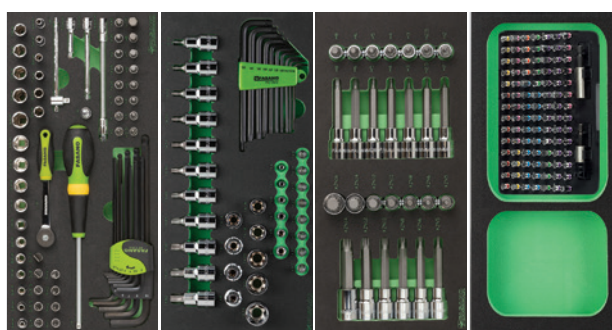

- FG 100/17E: Modulo 65 utensili da 1/4"
- FG 100/21TX: Modulo utensili torx con attacco 1/4" e 1/2"
- FG 100/81F: Modulo inserti a bussola esagonali e XZN 1/2"
- FG 100/48E: Modulo 98 inserti con attacco 1/4" e 2 porta inserti

### 3° CASSETTO

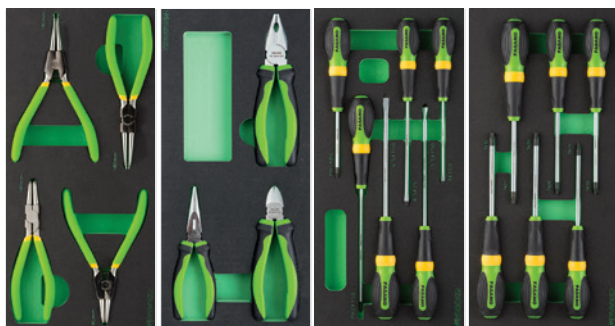

- FG 100/42C: Modulo 4 pinze per anelli elastici 19-60mm
- FG 100/39XT: Modulo 3 pinze assortite - serie industrial
- FG 100/45D: Modulo 6 giraviti a taglio e croce
- FG 100/45I: Modulo 6 giraviti con impronta Torx

### 4° CASSETTO

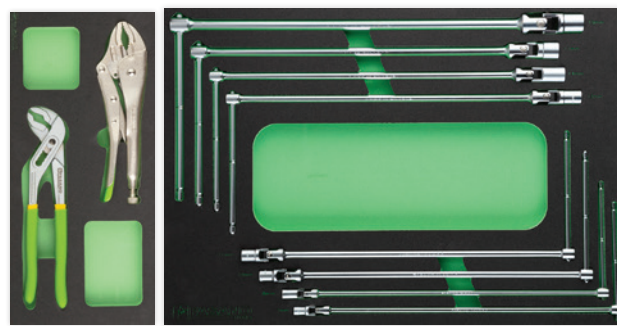

- FG 100/65B: Modulo pinze autobloccanti
- FG 100/10C: Modulo 8 chiavi a T snodate 7-19mm



MANIGLIONE  
IN ACCIAIO INOX

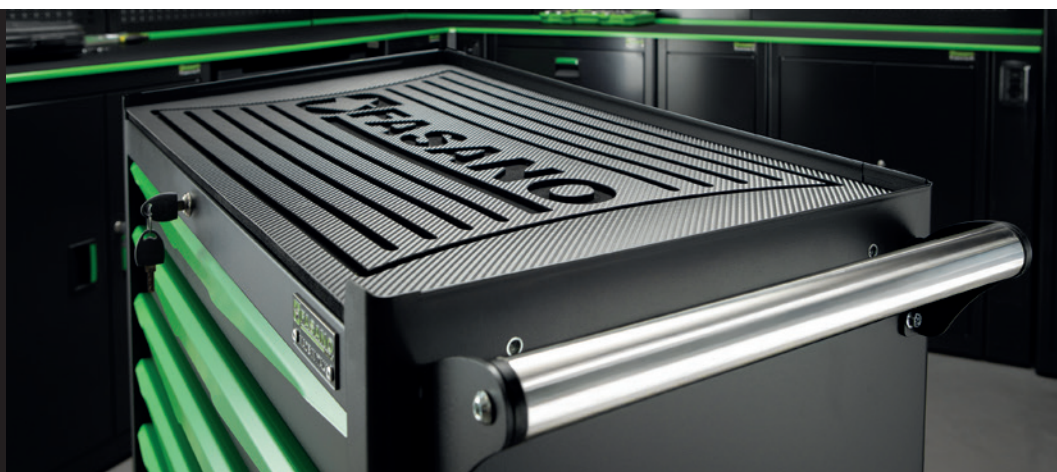

**FG 162V/AS308**

€LISTINO  
**6.163,50**

**PROMO**  
**2.799,00€**

**CARRELLO PORTA UTENSILI FG 162 A 14 CASSETTI  
CON ASSORTIMENTO 308 UTENSILI IN MODULI DI GOMMA**



**CODICE**

FG 162V/AS308	FG 162B/AS308	FG 162R/AS308	FG 162D/AS308
---------------	---------------	---------------	---------------

**ASSORTIMENTO 308 UTENSILI**

**1° CASSETTO**

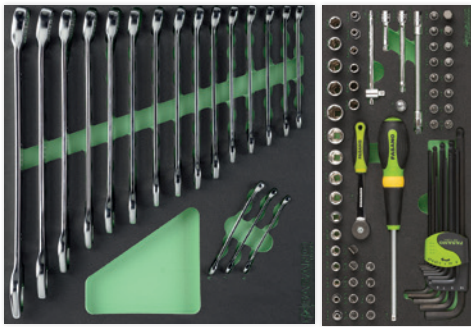

- FG 100/03H: Modulo 18 chiavi combinate in mm
- FG 100/17E: Modulo 65 utensili da 1/4"

**2° CASSETTO**



- FG 100/21B: Modulo chiavi a bussola esagonali 1/2" 8-32mm + accessori
- FG 100/21TX: Modulo utensili torx con attacco 1/4" e 1/2"
- FG 100/19: Modulo utensili con attacco quadro 3/8"

**3° CASSETTO**

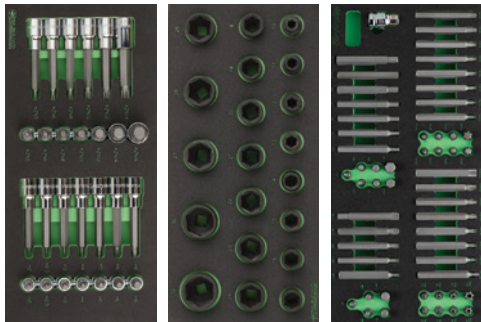

- FG 100/81F: Modulo inserti a bussola con attacco quadro 1/2"
- FG 100/23C: Modulo 20 chiavi a bussola rinforzate
- FG 100/48C: Modulo inserti corti e lunghi con attacco 10mm

**4° CASSETTO**

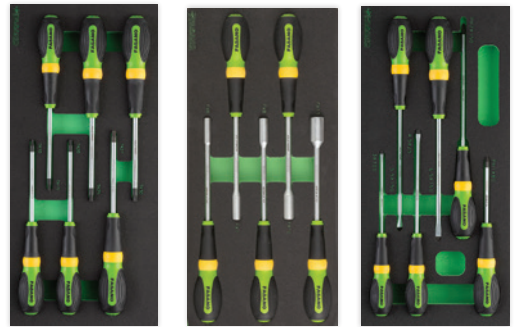

- FG 100/45I: Modulo 6 giraviti con impronta Torx
- FG 100/45T: Modulo 5 giraviti a bussola esagonali
- FG 100/45D: Modulo 6 giraviti a taglio e croce

**5° CASSETTO**



- FG 100/65B: Modulo pinze autobloccanti
- FG 100/39XT: Modulo 3 pinze assortite - serie industrial
- FG 100/42C: Modulo 4 pinze per anelli elastici 19-60mm

**6° CASSETTO**

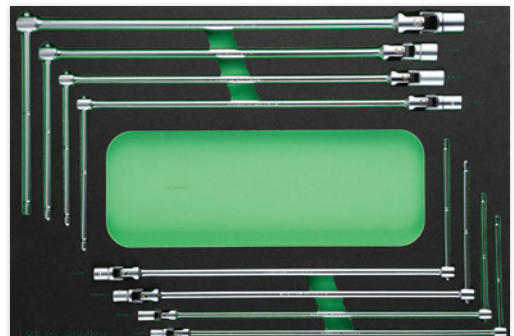

- FG 100/10C: Modulo 8 chiavi a T snodate 7-19mm



# CARRELLI E BANCHI DA LAVORO

**MODULO 14 CHIAVI COMBinate IN MM**  
FG 600/B6,7,8,9,10,11,12,13,14,15,16,17,18,19mm



1/3

CODICE	CHIAVE	€/LISTINO	€/PROMO
FG 100/03G	FG 600/B	160,00€	95,00€
FG 100/03G-A	FG 600/A	170,00€	99,90€

**MODULO 6 CHIAVI COMBinate IN MM**  
FG 600/B21,22,24,27,30,32mm



1/3

CODICE	CHIAVE	€/LISTINO	€/PROMO
FG 100/03L	FG 600/B	158,00€	95,00€
FG 100/03L-A	FG 600/A	168,00€	99,90€

**MODULO 18 CHIAVI COMBinate IN MM**  
FG 600/B6,7,8,10,11,12,13,14,16,17,18,19,21,22,24,27,30,32mm



2/3

CODICE	CHIAVE	€/LISTINO	€/PROMO
FG 100/03H	FG 600/B	310,00€	189,00€
FG 100/03H-A	FG 600/A	320,00€	195,00€

**FG 100/03E**

€/LISTINO

~~98,00~~

**PROMO 59,90€**

**MODULO 8 CHIAVI DOPPIA FORCHETTA**  
FG 602/B6x7,8x9,10x11,12x13,14x15,16x17,18x19,20x22 mm + FG 139C/FS



1/3

**FG 100/03F**

€/LISTINO

~~110,00~~

**PROMO 64,90€**

**MODULO 5 CHIAVI DOPPIA FORCHETTA**  
FG 602/B21x23,24x26,25x28,27x29,30x32 mm



1/3

**FG 100/07C**

€/LISTINO

~~112,00~~

**PROMO 65,90€**

**MODULO 7 CHIAVI DOPPIE POLIGONALI**  
FG 615/B6x7,8x9,10x11,12x13,14x15,16x17,18x19mm

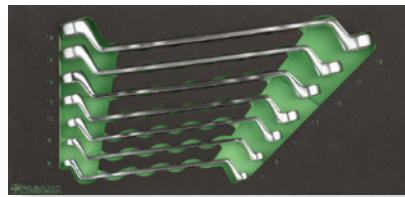

1/3

**FG 100/07D**

€/LISTINO

~~160,00~~

**PROMO 97,90€**

**MODULO 5 CHIAVI DOPPIE POLIGONALI**  
FG 615/B20x22,21x23,24x27,25x28,30x32mm

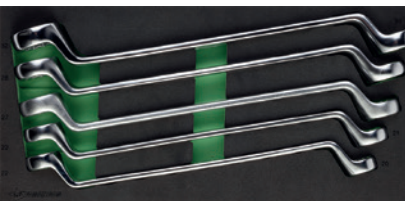

1/3

**FG 100/08C**

€/LISTINO

~~265,00~~

**PROMO 149,00€**

**MODULO 8 CHIAVI A CRICCHETTO**  
FG 605/B8,10,11,12,13,14,15,16,17,18,19mm



1/3

**FG 100/10C**

€/LISTINO

~~390,00~~

**PROMO 239,00€**

**MODULO 8 CHIAVI A T SNODATE**  
FG 618/A7,8,10,11,13,14,17,19 mm

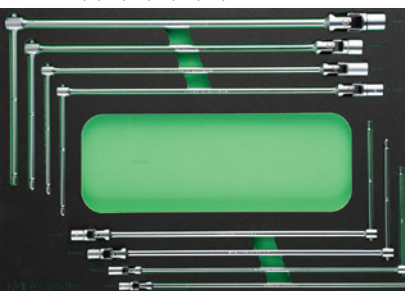

1/1

**FG 100/10D**

€/LISTINO  
~~570,00~~

**PROMO**  
**349,00€**

MODULO 12 CHIAVI A T SNODATE  
FG 618/A7,8,10,11,12,13,14,15,16,17,18,19 mm



1/1

**FG 100/17**

€/LISTINO  
~~145,00~~

**PROMO**  
**85,00€**

MODULO CHIAVI A BUSSOLA ESAGONALI  
4-14mm

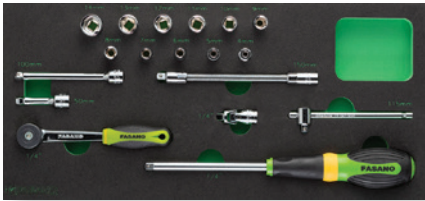

1/3

1/4"

**FG 100/17E**

€/LISTINO  
~~290,00~~

**PROMO**  
**175,00€**

MODULO CHIAVI A BUSSOLA ESAGONALI



1/3

1/4"

**FG 100/18**

€/LISTINO  
~~295,00~~

**PROMO**  
**179,00€**

MODULO CHIAVI A BUSSOLA ESAGONALI  
9-19mm

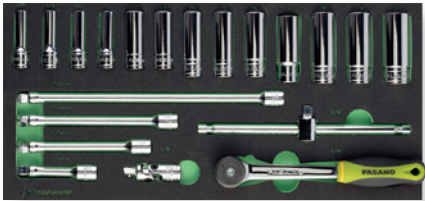

1/3

3/8"

**FG 100/19**

€/LISTINO  
~~240,00~~

**PROMO**  
**145,00€**

MODULO CHIAVI A BUSSOLA ESAGONALI  
9-19mm



1/3

3/8"

MODULO CHIAVI A BUSSOLA ESAGONALI  
10-32mm



1/3

1/2"

CODICE	ATTACCO	€/LISTINO	€/PROMO
FG 100/21B	Esagonale	250,00€	149,00€
FG 100/21C	Poligonale	250,00€	149,00€

MODULO CHIAVI A BUSSOLA ESAGONALI  
10-32mm

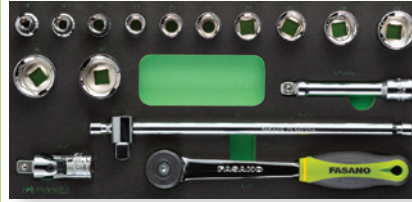

1/3

1/2"

CODICE	ATTACCO	€/LISTINO	€/PROMO
FG 100/21M	Esagonale	170,00€	99,00€
FG 100/21D	Poligonale	170,00€	99,00€

**FG 100/21H**

€/LISTINO  
~~440,00~~

**PROMO**  
**269,00€**

MODULO CHIAVI A BUSSOLA ESAGONALI  
Bussole corte: 8-32 mm (esclusa 25mm)  
Bussole lunghe: 10-32 mm

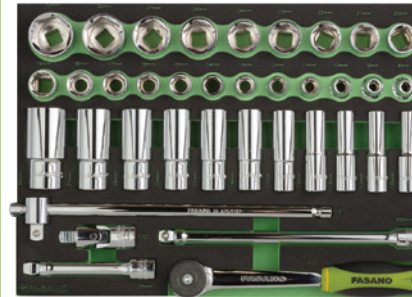

2/3

1/2"

**FG 100/21TX**

€/LISTINO  
~~270,00~~

**PROMO**  
**159,00€**

MODULO UTENSILI CON IMPRONTA TORX

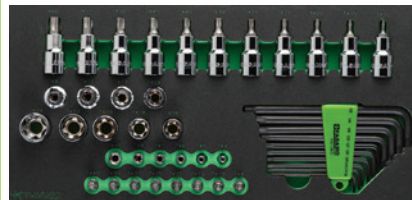

1/3

1/4"

1/2"

**FG 100/81F**

€/LISTINO  
~~200,00~~

**PROMO**  
**119,00€**

MODULO INSERTI A BUSSOLA  
FG 150/H2-H8, FG 150L/H2-H8,  
FG 150/M5-M16, FG 150L/M5-M14

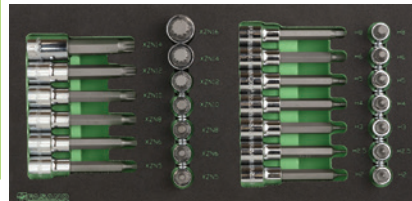

1/3



# CARRELLI E BANCHI DA LAVORO

## FG 100/23C

€/LISTINO  
~~220,00~~

PROMO  
**135,00€**

### MODULO 20 CHIAVI A BUSSOLA RINFORZATE

FG 628/C10, 11, 12, 13, 14, 15, 16, 17, 18, 19,  
21, 22, 23, 24, 25, 26, 27, 30, 32mm

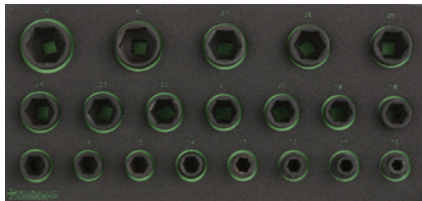

1/3

1/2"



## FG 100/65C

€/LISTINO  
~~136,00~~

PROMO  
**82,90€**

### MODULO PINZE AUTOBLOCCANTI

FG 70/CJ250 - FG 58/A240 - FG 49/HE250



1/3

## FG 100/23B

€/LISTINO  
~~360,00~~

PROMO  
**219,00€**

### MODULO 19 CHIAVI A BUSSOLA RINFORZATE

FG 628/L10, 11, 12, 13, 14, 15, 16, 17, 18, 19,  
21, 22, 23, 24, 25, 27, 29, 30, 32mm



1/3

1/2"



## FG 100/45D

€/LISTINO  
~~69,00~~

PROMO  
**41,90€**

### MODULO 6 GIRAVITI TAGLIO E CROCE

FG 22/3x100, 4x125, 5.5x200, 6.5x150,  
FG 22/PH1x80, PH2x150



1/3



## FG 100/39XT

€/LISTINO  
~~110,00~~

PROMO  
**66,90€**

### MODULO 3 PINZE ASSORTITE - SERIE INDUSTRIAL

FG 59/XT180 - FG 61/XT160 - FG 63/XT160

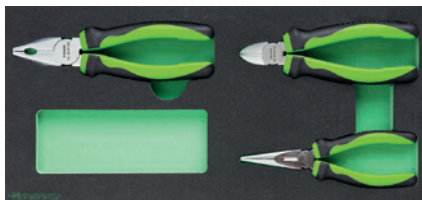

1/3

## FG 100/45E

€/LISTINO  
~~84,00~~

PROMO  
**49,90€**

### MODULO 8 GIRAVITI TAGLIO E CROCE

3x100, 4x125, 5.5x150, 6.5x150, 6.5x38,  
PH1x80, PH2x150, PH2x38



1/3



### MODULO 4 PINZE PER ANELLI ELASTICI INTERNI ED ESTERNI

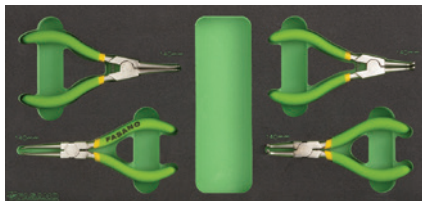

1/3

## FG 100/45F

€/LISTINO  
~~70,00~~

PROMO  
**42,90€**

### MODULO 6 GIRAVITI A CROCE PHILLIPS

PH0x60, PH1x150, PH2x100, PH2x150, PH3x150, PH2x38



1/3



CODICE	CAPACITÀ	€/LISTINO	€/PROMO
FG 100/41C	8-25mm	113,00€	67,90€
FG 100/42C	19-60mm	118,00€	71,90€

## FG 100/65B

€/LISTINO  
~~93,50~~

PROMO  
**54,90€**

### MODULO PINZE AUTOBLOCCANTI

FG 58/B240, FG 69/CJ250



1/3

## FG 100/45G

€/LISTINO  
~~70,00~~

PROMO  
**42,90€**

### MODULO 7 GIRAVITI A TAGLIO

2.5x60, 3x100, 3.5x100, 4x125, 5.5x150, 5.5x100, 6.5x150



1/3



**FG 100/45I**

€/LISTINO  
~~85,00~~

**PROMO**  
**51,90€**

MODULO 6 GIRAVITI CON IMPRONTA TORX  
TX10, TX15, TX20, TX25, TX27, TX30

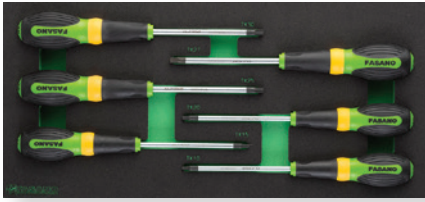

**FG 100/50F**

€/LISTINO  
~~90,00~~

**PROMO**  
**54,90€**

MODULO 6 CHIAVI MASCHIO ESAGONALI  
FG 142/2, 2.5, 3, 4, 5, 6

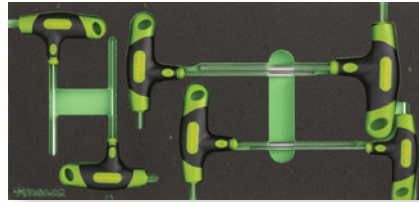

**FG 100/45T**

€/LISTINO  
~~88,00~~

**PROMO**  
**52,90€**

MODULO 5 GIRAVITI A BUSSOLA ESAGONALE  
FG 22/FX6, FX7, FX8, FX10, FX13



**FG 100/50G**

€/LISTINO  
~~90,00~~

**PROMO**  
**54,90€**

MODULO 6 CHIAVI MASCHIO TORX  
FG 143/TX10, TX15, TX20, TX25, TX27, TX30

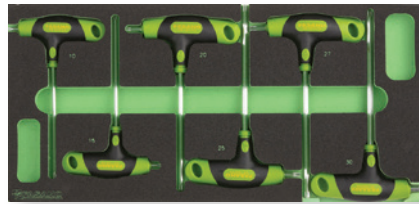

**FG 100/45H**

€/LISTINO  
~~80,00~~

**PROMO**  
**49,00€**

MODULO 5 GIRAVITI EXTRA LUNGI  
FG 22/2.5x300, 4x400, 5.5x400, FG 22/PH1x400, PH2x400

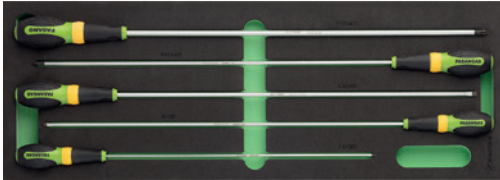

**FG 100/56C**

€/LISTINO  
~~135,00~~

**PROMO**  
**82,90€**

MODULO UTENSILI DA PERCUSSIONE  
FG 132/500, FG 136/40 - FG 126/SN1, FG 126/SN3



**FG 100/48G**

€/LISTINO  
~~130,00~~

**PROMO**  
**79,90€**

MODULO 52 INSERTI - ATTACCO 10MM

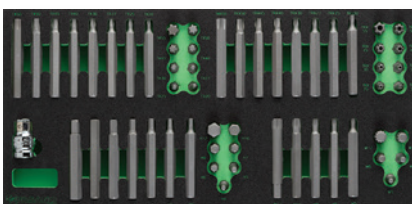

**FG 100/54**

€/LISTINO  
~~180,00~~

**PROMO**  
**109,00€**

MODULO 5 UTENSILI DI MISURAZIONE  
FG 95/CA, FG 188/2, FG 95/M1, FG 81/PT1, FG 44/MT5



**FG 100/51H**

€/LISTINO  
~~145,00~~

**PROMO**  
**89,00€**

MODULO 7 CHIAVI MASCHIO ESAGONALI  
FG 621/H2, 2.5, 3, 4, 5, 6, 8mm

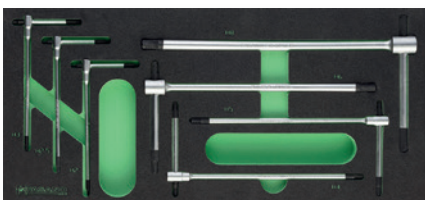

**FG 100/76C**

€/LISTINO  
~~275,00~~

**PROMO**  
**169,00€**

MODULI TAPPI E CHIAVI FILTRO OLIO  
FG 176/F01 - FG 176/RE - FG 175/S15





## MODULI IN GOMMA A PIENO CASSETTO

### IMPRONTA BI COLORE

SPECIFICHE DELL' UTENSILE IMPRESSO CON LASER, PER TROVARE A COLPO D'OCCHIO TUTTO CIÓ CHE SERVE E RISPARMIARE TEMPO



#### FG 100/03M

MODULO CHIAVI COMBinate POLIGONALI E POLIGONALI  
DOPPIE CURVE

33  
PEZZI

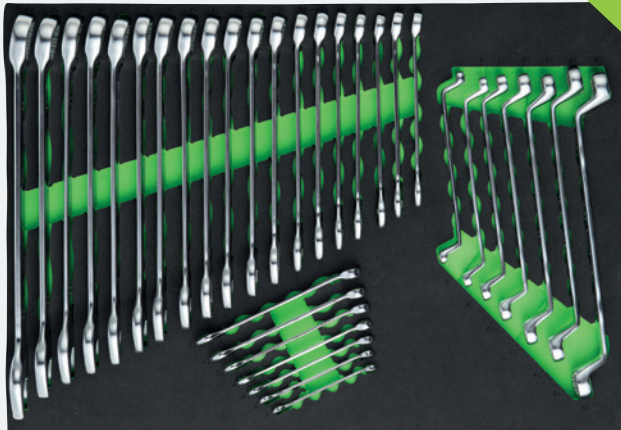

##### FG 600/B

Chiavi combinate poligonali  
6, 7, 8, 9, 10, 11, 12, 13, 14, 15, 16, 17, 18, 19, 20, 21, 22, 23, 24, 25,  
26, 27, 28, 29, 30, 32



##### FG 615/B

Chiavi poligonali doppie curve  
6x7, 8x9, 10x11, 12x13, 14x15, 16x17, 18x19



€/LISTINO

~~565,00~~

PROMO

**279,00€**

#### FG 100/45R

MODULO GIRAVITI IMPRONTE A INTAGLIO, PHILLIPS,  
ESAGONALI SFERICHE E TORX

25  
PEZZI

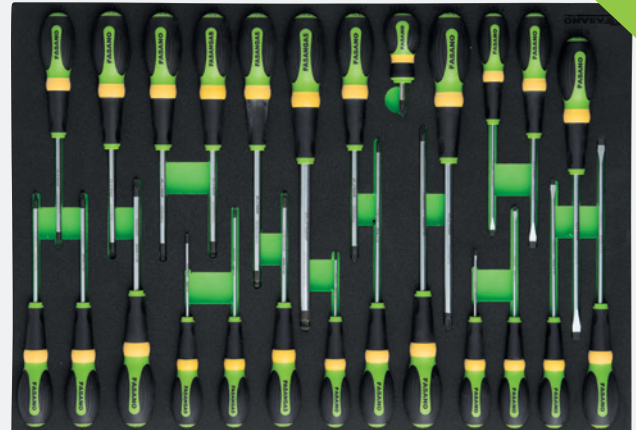

##### FG 22/PH

Giraviti per viti con testa a croce Phillips  
0x60, 1x150, 2x100, 2x150, 3x150



##### FG 22/PH

Giravite per viti con testa a croce Phillips - serie Stubby  
2x30



##### FG 22/

Giraviti per viti con testa a intaglio  
2.5x60, 3x100, 3.5x100, 4x125, 5.5x150, 5.5x100, 6.5x150



##### FG 22/TX

Giraviti per viti con impronta Torx  
10, 15, 20, 25, 27, 30



##### FG 22/H

Giraviti per viti con impronta esagonale sferica  
2.5, 3, 4, 5, 6, 8



€/LISTINO

~~276,40~~

PROMO

**159,00€**

**FG 100/39F**  
MODULO GIRAVITI, PINZE ED INSERTI

**128**  
PEZZI



**FG 22/PH**  
Giraviti per viti con testa a croce Phillips  
1x150, 2x100

**FG 22/**  
Giraviti per viti con testa a intaglio  
3x100, 4x125, 5.5x100

**FG 22/TX**  
Giraviti per viti con impronta Torx  
10, 15, 20, 25, 27, 30

**FG 59/XT180**  
Pinza universale  
180mm

**FG 63/XT160**  
Tronchese a taglianti diagonali  
160mm

**FG 51/180**  
Pinza a becchi dritti per anelli elastici esterni  
180mm

**FG 53/180**  
Pinza a becchi dritti per anelli elastici interni  
180mm

**FG 139**  
Chiavi maschio a L con impronta esagonale sferica  
1.5, 2, 2.5, 3, 4, 4.5, 5, 5.5, 6, 7, 8, 10

**FG 85/S100**  
Set 98 inserti da 1/4" + 2 porta inserti  
PH 0, 1, 2, 3; PZ 0, 1, 2, 3; Tri-Wing 1, 2, 3, 4, 6, 8, 10; XZN 5, 6, 8;  
TX 8, 9, 10, 15, 20, 25, 27, 30, 40, 45; S 0, 1, 2, 3;  
TX 8, 10, 15, 20, 25, 27, 30, 35, 40; SL 3, 4, 4.5, 5, 5.5, 6, 6.5, 7;  
H 1.5, 2, 2.5, 3, 4, 5, 5.5, 6, 1/16, 5/64, 3/32, 7/64, 1/8, 9/64,  
5/32, 3/16, 7/32, 1/4;  
HTR 2, 2.5, 3, 4, 5, 6, 5/64, 3/32, 7/64, 1/8, 9/64, 5/32; SP 4, 6, 8, 10;  
SP 5/32, 3/16, 1/4 + 2 porta inserti 1/4"

**FG 88/P14**  
Porta inserti con manico bi-materiale  
258mm

€ LISTINO  
~~432,00~~

**PROMO**  
**249,00€**

**FG 100/39E**  
MODULO PINZE ED INSERTI

**122**  
PEZZI



**FG 59/XT180**  
Pinza universale  
180mm

**FG 63/XT160**  
Tronchese a taglianti diagonali  
160mm

**FG 61/XT160**  
Pinza becchi mezzotondi dritti  
160mm

**FG 69/CJ250**  
Pinza regolabile autobloccante con ganasce concave  
250mm

**FG 58/B240**  
Pinza regolabile a cerniera chiusa  
240mm

**FG 85/S100**  
Set 98 inserti da 1/4" + 2 porta inserti  
PH 0, 1, 2, 3; PZ 0, 1, 2, 3; Tri-Wing 1, 2, 3, 4, 6, 8, 10; XZN 5, 6, 8;  
TX 8, 9, 10, 15, 20, 25, 27, 30, 40, 45; S 0, 1, 2, 3;  
TX 8, 10, 15, 20, 25, 27, 30, 35, 40; SL 3, 4, 4.5, 5, 5.5, 6, 6.5, 7;  
H 1.5, 2, 2.5, 3, 4, 5, 5.5, 6, 1/16, 5/64, 3/32, 7/64, 1/8, 9/64,  
5/32, 3/16, 7/32, 1/4;  
HTR 2, 2.5, 3, 4, 5, 6, 5/64, 3/32, 7/64, 1/8, 9/64, 5/32; SP 4, 6, 8, 10;  
SP 5/32, 3/16, 1/4 + 2 porta inserti 1/4"

**FG 88/P14**  
Porta inserti con manico bi-materiale

**FG 139**  
Chiavi maschio a L con impronta esagonale sferica  
1.5, 2, 2.5, 3, 4, 4.5, 5, 5.5, 6, 7, 8, 10

**FG 51/180**  
Pinza a becchi dritti per anelli elastici esterni  
180mm

**FG 52/180**  
Pinza a becchi a 90° per anelli elastici esterni  
180mm

**FG 53/180**  
Pinza a becchi dritti per anelli elastici interni  
180mm

**FG 54/180**  
Pinza a becchi a 90° per anelli elastici interni  
180mm

€ LISTINO  
~~475,40~~

**PROMO**  
**259,00€**



# CARRELLI E BANCHI DA LAVORO

## FG 100/21F

MODULO CHIAVI A BUSSOLA ESAGONALI, INSERTI E ACCESSORI 1/4", 3/8", 1/2"

115 PEZZI



**FG 624/E - FG 624E/L**  
Chiavi a bussola esagonali 1/4" -serie normale e serie lunga  
4, 5, 6, 7, 8, 9, 10, 11, 12, 13, 14

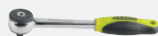

**FG 624/CR14**  
Cricchetto reversibile con attacco quadro maschio 1/4" a 72 denti



**FG 624/PA**  
Prolunghe con attacco quadro maschio e femmina 1/4" angolari  
50, 100mm



**FG 624/PRF150**  
Prolunga con attacco quadro maschio e femmina 1/4"  
150mm



**FG 624/ES14**  
Quadro maschio scorrevole 1/4"



**FG 624/SN14**  
Snodo con attacco quadro maschio e femmina 1/4"



**FG 624/GR14C**  
Quadro maschio 1/4" con impugnatura



**FG 147/H**  
Chiavi a bussola da 1/4" con inserto per viti ad impronta esagonale  
2,5, 3, 4, 5, 6, 7, 8, 10



**FG 147/PH**  
Chiavi a bussola da 1/4" con inserto per viti ad impronta a croce Phillips  
1, 2, 3, 4



**FG 147/TX**  
Chiavi a bussola da 1/4" con inserto per viti ad impronta Torx  
9, 10, 15, 20, 25, 27, 30, 40



**FG 147/SL**  
Chiavi a bussola da 1/4" con inserto per viti con impronta a taglio  
4, 5,5, 6,5, 8, 10



**FG 139/L**  
Chiavi maschio a L con impronta sferica - serie lunga  
1,5, 2, 2,5, 3, 4, 4,5, 5, 5,5, 6, 7, 8, 10



**FG 624B/PA**  
Prolunghe con attacco quadro maschio e femmina 3/8" angolari  
75, 125, 150, 250



**FG 624/SN38**  
Snodo con attacco quadro maschio e femmina 3/8"



**FG 624/ES38**  
Quadro maschio scorrevole 3/8"



**FG 624/CR38**  
Cricchetto reversibile con attacco quadro maschio 3/8" a 72 denti



**FG 624/B**  
Chiavi a bussola esagonali - attacco 3/8"  
8, 9, 10, 11, 12, 13, 14, 15, 16, 17, 18, 19, 21, 22, 23



**FG 625/A**  
Chiavi a bussola esagonali - attacco 1/2"  
8, 9, 10, 11, 12, 13, 14, 15, 16, 17, 18, 19, 20, 21, 22, 23, 24, 25, 26, 27, 30, 32

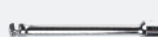

**FG 625/PA**  
Prolunghe con attacco quadro maschio e femmina 1/2" angolari  
125, 250

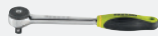

**FG 625/CR12**  
Cricchetto reversibile con attacco quadro maschio 1/2" a 72 denti



**FG 625/SN12**  
Snodo con attacco quadro maschio e femmina 1/2"



**FG 625/ES12**  
Quadro maschio scorrevole 1/2"

€LISTINO  
**1.036,00**

PROMO  
**599,00€**

## FG 100/81G

MODULO INSERTI E CHIAVI A BUSSOLA 1/4" E 1/2"

118 PEZZI



**FG 150/H**  
Chiavi a bussola da 1/2" con inserto per viti ad impronta esagonale  
2, 2,5, 3, 4, 5, 6, 8



**FG 150L/H**  
Chiavi a bussola da 1/2" con inserto lungo per viti ad impronta esagonale  
2, 2,5, 3, 4, 5, 6, 8



**FG 150/M**  
Chiavi a bussola da 1/2" con inserto per viti ad impronta XZN  
5, 6, 8, 10, 12, 14, 16



**FG 150L/M**  
Chiavi a bussola da 1/2" con inserto lungo per viti ad impronta XZN  
5, 6, 8, 10, 12, 14



**FG 624/TX**  
Chiavi a bussola Torx - attacco 1/4"  
4, 5, 6, 7, 8, 10



**FG 625/TX**  
Chiavi a bussola Torx - attacco 1/2"  
8, 10, 12, 14, 16, 18, 20, 22, 24



**FG 147/TX**  
Chiavi a bussola da 1/4" con inserto per viti ad impronta Torx  
9, 10, 15, 20, 25, 27, 30, 40



**FG 150/TX**  
Chiavi a bussola da 1/2" con inserto per viti ad impronta Torx  
10, 15, 20, 25, 27, 30, 40, 45, 50, 55, 60



**FG 138/C**  
Chiavi maschio a L con impronta Torx - serie lunga  
TX9, TX10, TX15, TX20, TX25, TX27, TX30, TX40, TX45, TX50



**FG 150/R**  
Chiavi a bussola da 1/2" con inserto per viti ad impronta RIBE  
4, 5, 6, 7, 8, 9, 10, 11, 12, 13, 14



**FG 150L/R**  
Chiavi a bussola da 1/2" con inserto lungo per viti ad impronta RIBE  
4, 5, 6, 7, 8, 9, 10, 11, 12, 13, 14



**FG 147/H**  
Chiavi a bussola da 1/4" con inserto per viti ad impronta esagonale  
2,5, 3, 4, 5, 6, 7, 8, 10



**FG 147/PH**  
Chiavi a bussola da 1/4" con inserto per viti ad impronta a croce Phillips  
1, 2, 3, 4



**FG 147/PT**  
Chiavi a bussola da 1/4" con inserto per viti ad impronta pentalobata  
1, 2, 3, 4



**FG 147/SL**  
Chiavi a bussola da 1/4" con inserto per viti con impronta a taglio  
4, 5,5, 6,5, 8, 10



**FG 624/CS14**  
Quadro maschio 1/4" snodato con impugnatura



**FG 625/CS12**  
Quadro maschio 1/2" snodato con impugnatura

€LISTINO  
**1.366,00**

PROMO  
**499,00€**

**FG 100/56D**

MODULO UTENSILI PER MANUTENZIONE GENERALE

**15  
PEZZI**



-  **FG 132/500**  
Martello tipo tedesco con manico in resina  
500 Gr
-  **FG 136/30**  
Mazzuola anti-rimbalzo con battenti intercambiabili in plastica  
Ø 30 mm
-  **FG 126/SN**  
Scalpelli nervati  
125mm, 200mm
-  **FG 95/CA**  
Calibro a corsoio, lettura cinquantennale  
150mm
-  **FG 80/8AR**  
Lima con impugnatura a taglio mezzodolce tonda  
8"
-  **FG 80/8AM**  
Lima con impugnatura a taglio mezzodolce mezzotonda  
8"
-  **FG 80/8AP**  
Lima con impugnatura a taglio mezzodolce piatta  
8"
-  **FG 80/8AQ**  
Lima con impugnatura a taglio mezzodolce quadrata 8"
-  **FG 80/8AT**  
Lima con impugnatura a taglio mezzodolce triangolare 8"
-  **FG 50/AR**  
Seghetto compatto con impugnatura  
Lama 140mm
-  **FG 48/LG**  
Cutter professionale con lama lunga  
16.7mm
-  **FG 497/OP2**  
Oliatore a pressione con cannuccia rientrante in ottone  
80cc
-  **FG 44/MT5**  
Flessometro con cassa in ABS anti-shock e nastro in acciaio  
rivestito in nylon  
5 metri
-  **FG 79/SP4**  
Spazzola con fili in acciaio ondulato ottonato  
270mm





€LISTINO ~~364,00~~ **PROMO 219,00€**

**FG 100/95B**

MODULO UTENSILI PER GOMMISTI

**18  
PEZZI**

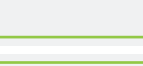
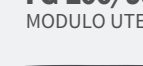

-  **FG 536/2**  
Chiave dinamometrica con cricchetto reversibile e aggancio 1/2"  
40-200Nm
-  **FG 628/R**  
Chiavi a bussola rinforzate per cerchi in lega leggera  
17,19,21mm
-  **FG 198/PE**  
Pinza per rimozione pesi adesivi equilibratura ruote
-  **FG 186P/S4**  
4 Leve in nylon
-  **FG 628R/L**  
Chiavi a bussola rinforzate per cerchi in lega leggera - mod. lungo  
17,19,21mm
-  **FG 126/P500**  
Leva per pneumatici dotata di protezione in ABS 500 mm
-  **FG 628/R**  
Chiavi a bussola rinforzate per dadi ruota  
16.5x17.5,18.5x19.5,21x21.5,22x22.5,27x27.5

€LISTINO ~~684,50~~ **PROMO 399,00€**

**FG 100/95C**

MODULO UTENSILI PER GOMMISTI

**41  
PEZZI**



-  **FG 628/R**  
Chiavi a bussola rinforzate per cerchi in lega leggera  
17,19,21mm
-  **FG 628/C**  
Chiavi a bussola esagonali rinforzate - attacco 1/2"  
10,11,12,13,14,15,16,17,18,19,20,21,22,23,24,25,26,27,30,32mm
-  **FG 628/L**  
Chiavi a bussola esagonali rinforzate lunghe - attacco 1/2"  
10,13,14,17,19,21,22,24
-  **FG 152/RH**  
Inserti a bussola rinforzati esagonali - attacco 1/2"  
5,6,7,8,10,12,14,17,19
-  **FGA 309**  
Avvitatore a impulsu 1/2"  
1700 Nm max

€LISTINO ~~818,50~~ **PROMO 469,00€**



## CARRELLI E BANCHI DA LAVORO



**FG 128/2**

€/LISTINO  
~~700,00~~

**PROMO**  
**349,00€**

### BANCO DA LAVORO 2.0MT

Ripiano superiore in lamiera d'acciaio zincato da 2mm

Peso totale: 59,5 Kg

Portata statica: 2000 Kg

Dimensioni: 2000x670x880 mm



**FG 128/D2**

€/LISTINO  
~~950,00~~

**PROMO**  
**479,00€**

### BANCO DA LAVORO 2.0MT DOTATO DI 2 CASSETTI

Ripiano superiore in lamiera d'acciaio zincato da 2mm

Peso totale: 74,5 Kg

Portata statica: 2000 Kg

Dimensioni: 2000x670x880 mm



FG 128/D2



FG 128/B2



FG 128/R2



**FG 129/2**

€/LISTINO  
~~850,00~~

**PROMO**  
**449,00€**

### BANCO DA LAVORO 2.0MT

Ripiano superiore in lamiera d'acciaio zincato da 3mm

Peso totale: 83 Kg

Portata statica: 2000 Kg

Dimensioni: 2000x745x880 mm



**FG 129/D2**

€/LISTINO  
~~1.100,00~~

**PROMO**  
**579,00€**

### BANCO DA LAVORO 2.0MT DOTATO DI 2 CASSETTI

Ripiano superiore in lamiera d'acciaio zincato da 3mm

Peso totale: 92 Kg

Portata statica: 2000 Kg

Dimensioni: 2000x745x880 mm



FG 129/D2



FG 129/B2



FG 129/R2



**FG 129/1**

€/LISTINO  
~~590,00~~

**PROMO**  
**289,00€**

**BANCO DA LAVORO 1.0MT**

Ripiano superiore in lamiera d'acciaio zincato da 3mm  
Ripiano inferiore in lamiera d'acciaio fornita di serie  
2 montanti  
Predisposizione per fissaggio a pavimento  
Struttura verniciata con vernice epossidica  
Peso totale: 58 Kg  
Portata statica: 2000 Kg  
Dimensioni: 1000x745x880 mm



**FG 129/D1**

€/LISTINO  
~~690,00~~

**PROMO**  
**359,00€**

**BANCO DA LAVORO 1.0MT DOTATO DI 1 CASSETTO**

Ripiano superiore in lamiera d'acciaio zincato da 3mm  
Ripiano inferiore in lamiera d'acciaio fornita di serie  
2 montanti  
Predisposizione per fissaggio a pavimento  
Struttura verniciata con vernice epossidica  
Peso totale: 64.5 Kg  
Portata statica: 2000 Kg  
Dimensioni: 1000x745x880 mm



FG 129/D1



FG 129/B1



FG 129/R1



**FG 129/1.5**

€/LISTINO  
~~650,00~~

**PROMO**  
**339,00€**

**BANCO DA LAVORO 1.5MT**

Ripiano superiore in lamiera d'acciaio zincato da 3mm  
Ripiano inferiore in lamiera d'acciaio fornita di serie  
2 montanti  
Predisposizione per fissaggio a pavimento  
Struttura verniciata con vernice epossidica  
Peso totale: 61 Kg  
Portata statica: 2000 Kg  
Dimensioni: 1500x745x880 mm



**FG 129/D1.5**

€/LISTINO  
~~790,00~~

**PROMO**  
**419,00€**

**BANCO DA LAVORO 1.5MT DOTATO DI 1 CASSETTO**

Ripiano superiore in lamiera d'acciaio zincato da 3mm  
Ripiano inferiore in lamiera d'acciaio fornita di serie  
2 montanti  
Predisposizione per fissaggio a pavimento  
Struttura verniciata con vernice epossidica  
Peso totale: 83.5 Kg  
Portata statica: 2000 Kg  
Dimensioni: 1500x745x880 mm



FG 129/D1.5

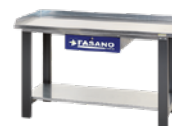

FG 129/B1.5



FG 129/R1.5



## CARRELLI E BANCHI DA LAVORO



**FG 137/D1.5**

€/LISTINO

~~1.400,00~~

**PROMO**  
**739,00€**

**BANCO DA LAVORO 1.5MT CON VASCA DI RACCOLTA  
DOTATO DI RUOTE GIREVOLI**

Ripiano microforato

Vasca di raccolta estraibile con capacità 30 litri

Peso totale: 90 Kg

Dimensioni: 1500x745x880 mm



FG 137/D1.5



FG 137/B1.5



FG 137/R1.5



**CASSETTO  
RACCOLTA FLUIDI**



**RUBINETTO DI  
SCARICO FLUIDI**



**RIPIANO MICROFORATO  
AMOVIBILE**



**FG 131/D2**

€/LISTINO

~~1.700,00~~

**PROMO**  
**899,00€**

**BANCO DA LAVORO 2.0MT CON RIPIANO IN ACCIAIO  
E CASSETTIERA 5 CASSETTI**

Peso totale: 121.50 Kg

Dimensioni: 2000x670x920 mm

Chiusura centralizzata



FG 131/D2



FG 131/B2



FG 131/R2



**FG 132/D2**

€/LISTINO

~~2.350,00~~

**PROMO**  
**1.249,00€**

**BANCO DA LAVORO 2.0MT CON RIPIANO IN ACCIAIO  
E 2 CASSETTIERE 5 CASSETTI**

Peso totale: 163 Kg

Dimensioni: 2000x745x920

Chiusura centralizzata



FG 132/D2



FG 132/B2



FG 132/R2



**FG 107/A**

€/LISTINO  
~~165,00~~

**PROMO**  
**79,00€**

**CARRELLO PORTA ATTREZZI IN LAMIERA D'ACCIAIO**

Lamiera d'acciaio: 1mm  
2 ruote fisse e 2 ruote girevoli con freno (Ø100mm)  
Profondità ripiano: 7,8 cm  
Portata statica distribuita in 3 ripiani: 90Kg  
Dimensioni: 730x380x780  
Peso kg: 16,4



**FG 106/B**

€/LISTINO  
~~336,00~~

**PROMO**  
**179,00€**

**CARRELLO PORTA ATTREZZI IN LAMIERA D'ACCIAIO**

Lamiera d'acciaio 1.5mm  
Ruote montate su supporto rotante a piastra con gruppo rotante realizzato con doppia corona di sfere  
2 ruote fisse, 1 girevole + 1 girevole con freno (Ø100mm)  
Dimensione: 460x930x885 mm  
Peso totale: 22 Kg



**FG 106/C**

€/LISTINO  
~~428,00~~

**PROMO**  
**199,00€**

**CARRELLO PORTA ATTREZZI IN LAMIERA D'ACCIAIO - MOD. GIGANTE**

Lamiera d'acciaio 2,0mm  
Ruote montate su supporto rotante a piastra con gruppo rotante realizzato con doppia corona di sfere  
2 ruote fisse, 1 girevole + 1 girevole con freno (Ø125mm)  
Dimensione: 560x1000x950 mm  
Peso totale: 44 Kg



**PRODUZIONE  
100% MADE IN ITALY**

# ARREDAMENTO FG 118 TECNICO



**VERNICIATURA  
SATINATA  
OPACA**

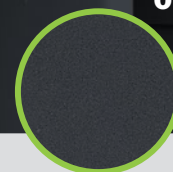

## I DETTAGLI CHE FANNO LA DIFFERENZA

- PRESE CON ATTACCO STANDARD, SHUKO E USB
- CASSETTIERE CON CASSETTI TOTALMENTE APRIBILI, DOTATI DI TAPPETINI IN GOMMA E PREDISPOSIZIONE PER I DIVISORI INTERNI

**700mm DI PROFONDITÀ  
DEL PIANO DI LAVORO  
IN ACCIAIO DA 3mm**

- ARMADIETTI CON 4 RIPIANI INTERNI E CERNIERE SOFT-CLOSING
- RIVESTIMENTO SUPERIORE IN POLICARBONATO E NUOVA FINITURA ANTIGRAFFIO
- PENSILI CON ANTE DOTATE DI PISTONI A GAS





**FG 118/CO2V**

€/LISTINO  
~~5.840,00~~

**PROMO**  
**2.499,00€**

**CONFIGURAZIONE DI ARREDAMENTO TECNICO DA 2050MM**

Configurazione composta da:

FG 118V/69A: Modulo armadietto con 2 antine

FG 118V/7T: Cassetiera mobile a 7 cassetti

FG 118V/40F: Modulo porta carta dotato di cassetto porta rifiuti

2 pensili superiori

2 griglie porta utensili

2 Prese in dotazione: 1 presa 220V a 2 poli, 1 presa Schuko a 2 poli + USB

Dimensioni: 2050x757x2000 mm



FG 118/CO2D



FG 118/CO2B



FG 118/CO2R



**FG 118/CO3V**

€/LISTINO  
~~6.620,00~~

**PROMO**  
**2.899,00€**

**CONFIGURAZIONE DI ARREDAMENTO TECNICO DA 2550MM**

Con igurazione composta da:

FG 117/AR1V: Armadio porta oggetti in metallo ad 1 antina

FG 118V/69A: Modulo armadietto con 2 antine

FG 118V/7T: Cassetiera mobile a 7 cassetti

FG 118V/40F: Modulo porta carta dotato di cassetto porta rifiuti

2 pensili superiori

2 griglie porta utensili

2 Prese in dotazione: 1 presa 220V a 2 poli, 1 presa Schuko a 2 poli + USB

Dimensioni: 2550x757x2000 mm



FG 118/CO3D



FG 118/CO3B



FG 118/CO3R



**FG 118/CO30V**

€/LISTINO  
**7.670,00**

**PROMO**  
**3.299,00€**

### CONFIGURAZIONE DI ARREDAMENTO TECNICO DA 3050MM

- FG 118V/205A: Struttura base per con igurazione da 2050mm, dotata di pensili superiori
  - FG 118V/40A: Modulo armadietto con antina singola
  - FG 118V/7T: Cassettiera mobile a 7 cassetti
  - FG 118/69V7: Cassettiera fissa a 7 cassetti
  - FG 117/AR1V: Armadio a un'anta
  - FG 117/AR1V: Armadio a un'anta
- Dimensioni mm (LxWxH): 3050x757x2000



FG 118/CO30D



FG 118/CO30B



FG 118/CO30R



**EFFETTO  
METALLICO**

**ANTISCIVOLO**

**ANTIMACCHIA**

**FG 117/PVC-1**

€/LISTINO  
~~21,00~~

**PROMO  
12,90€**

**PIASTRELLA IN PVC**

- Spessore 6mm
- Capacità di carico 15-20 t/m<sup>2</sup>
- Resistente agli agenti chimici
- Antiscivolo
- Antimacchia
- Pratico sistema di montaggio ad incastro
- Effetto metallico
- Ideale per officine, locali commerciali e industriali, ecc.

**DIMENSIONI:**  
500x500mm

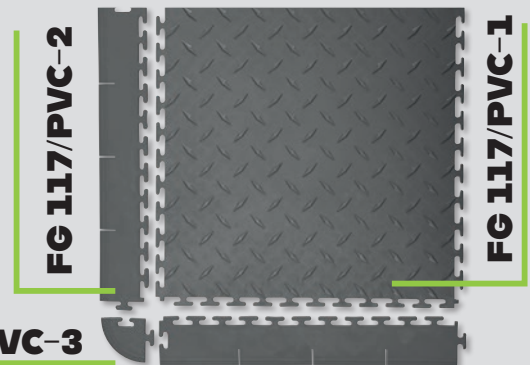

**FG 117/PVC-2**

€/LISTINO  
~~8,00~~

**PROMO  
4,90€**

**BORDO DI CHIUSURA**

**DIMENSIONI:**  
80x500mm



**FG 117/PVC-3**

€/LISTINO  
~~5,00~~

**PROMO  
2,90€**

**ANGOLO DI CHIUSURA**

**DIMENSIONI:**  
80x80mm



**FG 117PVC/S5**

€/LISTINO  
~~221,00~~

**PROMO  
129,00€**

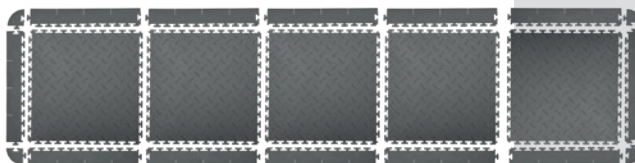

**SET 5 PIASTRELLE IN PVC  
CON BORDI E ANGOLI DI CHIUSURA**

- 5PZ FG 117/PVC -1 piastrella
- 12PZ FG 117/PVC -2 bordo
- 4PZ FG 117/PVC -3 angolare

**FG 117PVC/S6**

€/LISTINO  
~~258,00~~

**PROMO  
149,00€**

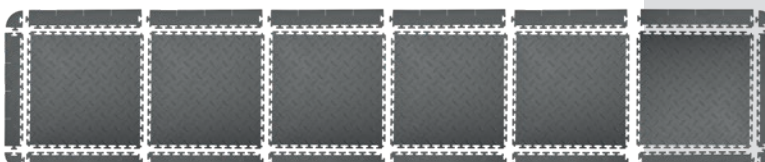

**SET 6 PIASTRELLE IN PVC  
CON BORDI E ANGOLI DI CHIUSURA**

- 6PZ FG 117/PVC -1 piastrella
- 14PZ FG 117/PVC -2 bordo
- 4PZ FG 117/PVC -3 angolare



## FG 118 + ASSORTIMENTO

# 351 PZ

DI UTENSILI IN MODULI  
A PIENO CASSETTO

DEL VALORE  
DI 1.980,00€

FG 118V/AS351

€/LISTINO  
~~11.399,30~~

PROMO  
4.699,00€

### CON ASSORTIMENTO DI 351 UTENSILI INDISPENSABILI



FG 118B/AS351



FG 118R/AS351



FG 118D/AS351



PIANO DI LAVORO IN ACCIAIO DA 3mm - PROFONDITÀ 70 cm

### CONFIGURAZIONE DI ARREDAMENTO TECNICO DA 3050 mm

FG 118V/205A: Struttura base dotata di 2 pensili superiori

FG 118V/7T: Cassetiera mobile a 7 cassetti

FG 118/69V7: Cassetiera fissa a 7 cassetti

FG 118V/40F: Modulo porta carta, dotato di cassetto porta rifiuti

FG 117/AR1V: Armadio porta oggetti ad 1 anta

FG 117/AR1V: Armadio porta oggetti ad 1 anta

DIMENSIONI:  
3050X757X2000mm

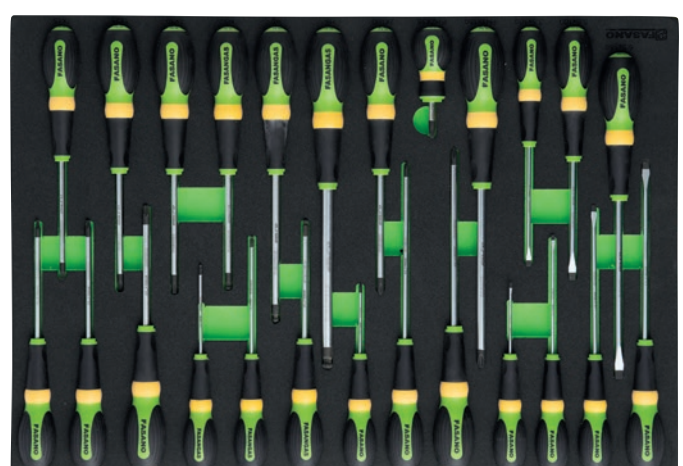
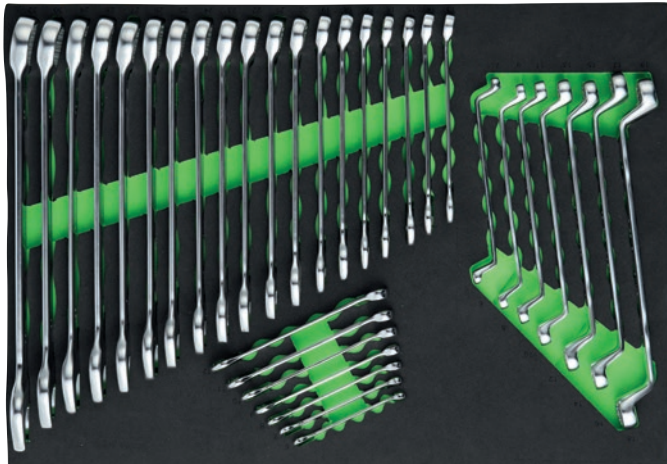

- FG 100/03M:** Modulo chiavi combinate poligonali (6-32mm) e poligonali doppie curve (6x7 - 18x19 mm)
- FG 100/21F:** Modulo chiavi a bussola esagonali, inserti e accessori 1/4", 3/8", 1/2"
- FG 100/39E:** Modulo pinze e inserti da 1/4"
- FG 100/45R:** Modulo giraviti impronte a intaglio, Phillips, esagonali sferiche e Torx
- FG 100/56D:** Modulo utensili per manutenzione generale
- FG 100/95C:** Modulo utensili per gommisti con avvitatore FGA 309

**FGA 309**  
**AVVITATORE AD IMPULSI 1/2"**





SCOPRI DI PIÙ

# SISTEMA DI ARREDAMENTO TECNICO FG 117



DISPONIBILE IN 4 VARIANTI COLORE



**NEW**

**PIANO DI LAVORO IN ACCIAIO DA 2mm**  
DOTATO DI TOP IN POLICARBONATO ANTIGRAFFIO  
DA OGGI DISPONIBILE IN DUE PROFONDITÀ

SCEGLI IL PIANO DA LAVORO PIU' ADATTO ALLE TUE ESIGENZE

La versione con profondita' da 600mm

ha il codice che termina con **FG 117/... - 60**



PROFONDITÀ 460mm



PROFONDITÀ 600mm

RIPIANI INTERNI E MECCANISMO DI CHIUSURA SOFT CLOSING

VERNICIATURA SATINATA OPACA

CASSETTI PREDISPOSTI PER DIVISORI INTERNI PORTA MINUTERIE



**FG 117/CO2V**

€/LISTINO  
~~4.525,00~~

**PROMO**  
**1.799,00€**

**PROFONDITÀ 460mm**

**FG 117/CO2V-60**

€/LISTINO  
~~4.825,00~~

**PROMO**  
**1.999,00€**

**PROFONDITÀ 600mm**

**CONFIGURAZIONI FG 117 DA 2070mm**

Configurazione composta da:  
 FG 117V/68A: Modulo armadietto  
 FG 117V/7G: Carrello porta utensili  
 FG 117V/68B: Armadietto, porta carta e porta rifiuti  
 3 griglie porta utensili  
 3 pensili superiori



FG 117/CO2D - FG 117/CO2D-60



FG 117/CO2B - FG 117/CO2B-60



FG 117/CO2R - FG 117/CO2R-60



**FG 117/CO3V**

€/LISTINO  
~~5.395,00~~

**PROMO**  
**2.199,00€**

**PROFONDITÀ 460mm**

**FG 117/CO3V-60**

€/LISTINO  
~~5.695,00~~

**PROMO**  
**2.399,00€**

**PROFONDITÀ 600mm**

**CONFIGURAZIONI FG 117 DA 2570mm + ARMADIO**

Configurazione composta da:  
 FG 117V/68A: Modulo armadietto  
 FG 117V/7G: Carrello porta utensili  
 FG 117V/68B: Armadietto, porta carta e porta rifiuti  
 FG 117/AR1V: Armadio ad un anta  
 3 griglie porta utensili  
 3 pensili superiori



FG 117/CO3D - FG 117/CO3D-60



FG 117/CO3B - FG 117/CO3B-60



FG 117/CO3R - FG 117/CO3R-60



## FG 117/CO25V

€/LISTINO  
~~5.675,00~~

PROMO  
**2.349,00€**

PROFONDITÀ 460mm

## FG 117/CO25V-60

€/LISTINO  
~~5.975,00~~

PROMO  
**2.549,00€**

PROFONDITÀ 600mm

### CONFIGURAZIONE FG 117 DA 2070mm + ARMADIO

- FG 117V/207A: Struttura con griglie porta utensili e 3 pensili superiori
- FG 117V/7G: Cassettiera mobile a 7 cassetti
- FG 117V/68A: Modulo armadietto con doppia antina
- FG 117V/68B: Modulo armadietto con 1 antina
- + modulo porta carta con cassetto porta rifiuti
- FG 117/AR2V: Armadio a due ante



FG 117/CO25D - FG 117/CO25D-60



FG 117/CO25B - FG 117/CO25B-60



FG 117/CO25R - FG 117/CO25R-60



## FG 117/CO24V

€/LISTINO  
~~6.000,00~~

PROMO  
**2.499,00€**

PROFONDITÀ 460mm

## FG 117/CO24V-60

€/LISTINO  
~~6.300,00~~

PROMO  
**2.699,00€**

PROFONDITÀ 600mm

### CONFIGURAZIONI FG 117 DA 2070mm + ARMADIO

- FG 117V/207A: Struttura base dotata di griglie porta-utensili e 3 pensili superiori
- FG 117V/7G: Carrello a 7 cassetti
- FG 117V/68V7: Cassettiera fissa a 7 cassetti
- FG 117V/68B: Modulo armadietto con 1 antina
- + modulo porta carta con cassetto porta rifiuti
- FG 117/AR2V: Armadio a due ante



FG 117/CO24D - FG 117/CO24D-60



FG 117/CO24B - FG 117/CO24B-60



FG 117/CO24R - FG 117/CO24R-60



**FG 117/CO16V**

€/LISTINO  
~~3.815,00~~

**PROMO**  
**1.699,00€**

**PROFONDITÀ 460mm**

**FG 117/CO16V-60**

€/LISTINO  
~~4.015,00~~

**PROMO**  
**1.859,00€**

**PROFONDITÀ 600mm**

**CONFIGURAZIONI FG 117 DA 1380MM + ARMADIO**

FG 117V/138A: Struttura base dotata di griglie porta-utensili e 2 pensili superiori

FG 117V/68A: Modulo armadietto

FG 117/68V5: Cassettiera fissa a 5 cassetti

FG 117/AR1V: Armadio ad un'anta



FG 117/CO16D - FG 117/CO16D-60



FG 117/CO16B - FG 117/CO16B-60



FG 117/CO16R - FG 117/CO16R-60

**FG 117/CO30V**

€/LISTINO  
~~8.480,00~~

**PROMO**  
**3.499,00€**

**PROFONDITÀ 460mm**

**FG 117/CO30V-60**

€/LISTINO  
~~9.080,00~~

**PROMO**  
**3.899,00€**

**PROFONDITÀ 600mm**



**CONFIGURAZIONI FG 117 AD ANGOLO**

Configurazione composta da:

FG 117V/207A: Struttura con griglie porta utensili e 3 pensili superiori

FG 117V/138A: Struttura base dotata di griglie porta-utensili e 2 pensili superiori

FG 117/50AN: Struttura angolare dotata di due griglie porta utensili

FG 117V/68B: Armadietto, porta carta e porta rifiuti

FG 117V/7G: Carrello porta utensili a 7 cassetti

FG 117V/68A: Modulo armadietto

FG 117/68V6: Cassettiera fissa a 6 cassetti

FG 117V/68A: Modulo armadietto



FG 117/CO30D - FG 117/CO30D-60



FG 117/CO30B - FG 117/CO30B-60



FG 117/CO30R - FG 117/CO30R-60



## FG 117

### L'ARREDO TECNICO DEI TUOI SOGNI AD UN PREZZO IMBATTIBILE



**FGA 383/AR15**  
AVVOLGITUBO  
AUTOMATICO  
PER ARIA  
COMPRESSA  
-15mt, Ø8X12mm

**FG 117V/AS266**

€/LISTINO

~~7.304,00~~

**PROMO**  
**2.999,00€**

**FG 117V/AS266-60**

€/LISTINO

~~7.624,00~~

**PROMO**  
**3.199,00€**

PROFONDITÀ **460mm**

PROFONDITÀ **600mm**

**CON ASSORTIMENTO DI 265 UTENSILI  
+ AVVITATORE IN OMAGGIO**



**FG 117B/AS266**  
**FG 117B/AS266-60**



**FG 117R/AS266**  
**FG 117R/AS266-60**



**FG 117D/AS266**  
**FG 117D/AS266-60**



### CONFIGURAZIONE DI ARREDAMENTO TECNICO DA 3070 mm

**FG 117V/207A:** Struttura con griglie porta utensili e 3 pensili superiori

**FG 117V/7G:** Cassettiera mobile a 7 cassetti

**FG 117V/68A:** Modulo armadietto con doppia antina

**FG 117V/68C:** Modulo aria compressa + modulo porta carta e cassetto porta rifiuti

**FG 117/AR2V:** Armadio a due ante

DIMENSIONI DISPONIBILI:

3070x510x2000mm

3070x630x2000mm



**ASSORTIMENTO**

**265 PZ**

**DI UTENSILI  
DEL VALORE  
DI 900,00 €**

**+ IN OMAGGIO  
AVVITATORE**

**FGA 309  
DEL VALORE  
DI 179,00€**



**1° CASSETTO**

**83 PZ**

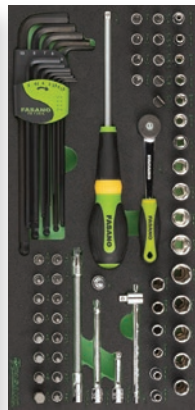

**FG 100/03H:** Modulo 18 chiavi combinate 6 - 32 mm  
**FG 100/17E:** Modulo chiavi a bussola esagonali da 1/4"

**2° CASSETTO**

**75 PZ**

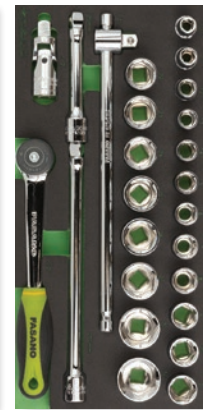

**FG 100/45D:** Modulo 6 giraviti taglio e croce  
**FG 100/21B:** Modulo chiavi a bussola esagonali da 1/2"  
**FG 100/21TX:** Modulo utensili con impronta Torx da 1/4" e 1/2"

**3° CASSETTO**

**107 PZ**

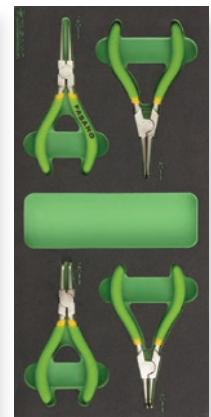

**FG 100/48E:** Modulo 98 inserti con attacco 1/4" + 2 porta inserti  
**FG 100/39XT:** Modulo 3 pinze assortite - serie Industrial  
**FG 100/42C:** Modulo 4 pinze per anelli elastici

**IN OMAGGIO**

**L'IMMANCABILE**

**FGA 309**

**AVVITATORE  
AD IMPULSI 1/2"**





**FG 117/CO26V**

€/LISTINO  
~~5.960,00~~

PROMO  
**2.699,00€**

PROFONDITÀ 460mm

**FG 117/CO26V-60**

€/LISTINO  
~~6.260,00~~

PROMO  
**2.899,00€**

PROFONDITÀ 600mm

NEW



**ORDINE  
E PULIZIA  
NEGLI SPAZI  
DI LAVORO**

**NUOVO MODULO  
CON LAVABO  
INTEGRATO**



**PIANO DI LAVORO IN ACCIAIO DA 2mm**

**CONFIGURAZIONE DI ARREDAMENTO TECNICO  
DA 2570 mm**

**FG 117V/138A:** Struttura con griglie porta utensili e 2 pensili superiori

**FG 117V/68LVA:** Modulo con griglia porta utensili, pensile superiore e armadietto con lavabo

**FG 117/68V7:** Cassetiera fissa a 7 cassetti

**FG 117V/68B:** Modulo armadietto con 1 antina + modulo porta carta con cassetto porta rifiuti

**FG 117/AR1V:** Armadio ad 1 anta

**DIMENSIONI DISPONIBILI:**

2570X510X2000mm  
2570X630X2000mm



**FG 117/CO26B  
FG 117/CO26B-60**



**FG 117/CO26R  
FG 117/CO26R-60**



**FG 117/CO26D  
FG 117/CO26D-60**

**FG 117V/68LVB**

€/LISTINO  
**1.150,00**

**PROMO**  
**599,00€**

**FG 117V/68LVB-60**

€/LISTINO  
**1.250,00**

**PROMO**  
**649,00€**

**PROFONDITÀ 460mm**

**PROFONDITÀ 600mm**

**NEW**



**MODULO FG 117 CON ARMADIETTO E LAVABO INTEGRATO**

- Due antine
- Ripiano interno amovibile
- Serratura centrale
- Vasca in acciaio inossidabile 400x340x140 mm

**INCLUSI:**  
RUBINETTO MISCELATORE  
GRUPPO DI SCARICO  
TAPPO DI CHIUSURA  
TAPPO FILTRO

**DIMENSIONI DISPONIBILI:**

680X460X1015mm  
680X600X1015mm



**FG 117B/68LVB**  
**FG 117B/68LVB-60**



**FG 117R/68LVB**  
**FG 117R/68LVB-60**



**FG 117D/68LVB**  
**FG 117D/68LVB-60**

**FG 117V/68LVA**

€/LISTINO  
**1.750,00**

**PROMO**  
**799,00€**

**FG 117V/68LVA-60**

€/LISTINO  
**1.850,00**

**PROMO**  
**849,00€**

**PROFONDITÀ 460mm**

**PROFONDITÀ 600mm**

**NEW**



**INCLUSI:**  
RUBINETTO MISCELATORE  
GRUPPO DI SCARICO  
TAPPO DI CHIUSURA  
TAPPO FILTRO

**MODULO FG 117 CON PENSILE E ARMADIETTO CON LAVABO INTEGRATO**

- Struttura base con griglia e pensile superiore
- Modulo armadietto con lavabo integrato

**DIMENSIONI DISPONIBILI:**  
690X490X2000mm  
690X630X2000mm



**FG 117B/68LVA**  
**FG 117B/68LVA-60**



**FG 117R/68LVA**  
**FG 117R/68LVA-60**



**FG 117D/68LVA**  
**FG 117D/68LVA-60**



## ARREDAMENTO FURGONI

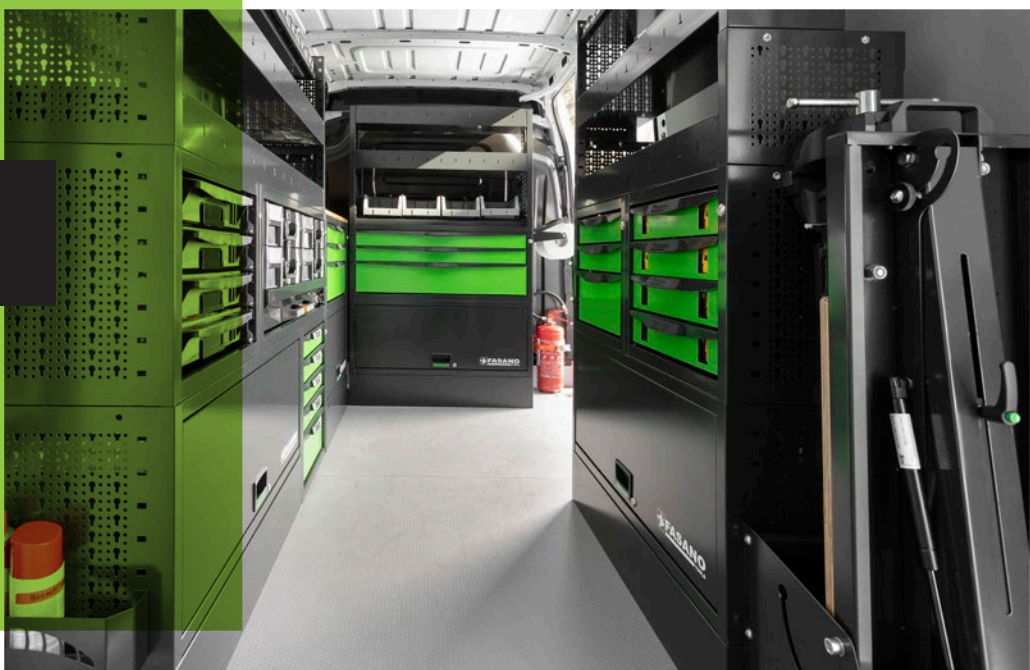

### FG 119V/CO16

€/LISTINO

~~1.870,80~~

**PROMO**  
**899,00€**

#### CONFIGURAZIONE ARREDAMENTO TECNICO PER FURGONI

Dimensioni mm: 980x400x1157

Peso kg: 61,8

Comprende (dall'alto verso il basso)

FG 119/MRT40-9: coppie montanti laterali

FG 119/RP40-92: ripiano con divisori amovibili

FG 119V/C49-3: cassetiera a 3 cassette

FG 119V/C49-4: cassetiera a 4 cassette

FG 119V/BA98: base aperta

FG 119/RI98: rialzo per basi aperte o chiuse

FG 119/KS: kit staffaggio



FG 119V/CO16



FG 119B/CO16



FG 119R/CO16



MANIGLIE IN ABS  
CON IMPUGNATURA  
ERGONOMICA



CASSETTI CON  
APERTURA COMPLETA  
PER MODULI PORTA UTENSILI



VALIGIE COMPONENTI  
CON SCOMPARTI  
PORTA MINUTERIE



ANTE ESTRAIBILI  
AD APERTURA TOTALE



VASCHE IN PLASTICA  
PORTA MINUTERIE

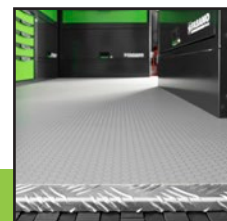

PIANALI  
ANTISCIVOLO



**FG 119V/CO12**

€/LISTINO  
~~2.315,20~~

**PROMO**  
**1.199,00€**

**CONFIGURAZIONE ARREDAMENTO TECNICO PER FURGONI**

Dimensioni mm: 980x400x1592

Peso kg: 74,9

Comprende (dall'alto verso il basso)

- FG 119/M30-40: coppie montanti laterali
- FG 119/RV30-92: ripiano con vaschette in plastica
- FG 119/RP30-92: ripiano con divisori amovibili
- FG 119/M40-23: coppie montanti laterali
- FG 119/RP40-92: ripiano con divisori amovibili
- FG 119V/C49-3: cassetiera a 3 cassetti
- FG 119V/C49-4: cassetiera a 4 cassetti
- FG 119V/BA98: base aperta
- FG 119/R198: rialzo per basi aperte o chiuse
- FG 119/KS: kit staffaggio



FG 119V/CO12

FG 119B/CO12

FG 119R/CO12



**FG 119V/CO25**

€/LISTINO  
~~1.870,80~~

**PROMO**  
**989,00€**

**CONFIGURAZIONE ARREDAMENTO TECNICO PER FURGONI**

Dimensioni mm: 1225x400x1067

Peso kg: 76,2

Comprende (dall'alto verso il basso)

- FG 119/MRT40-9: coppie di montanti laterali
- FG 119/RP40-116: ripiano con divisori amovibili
- FG 119V/C49-4: cassetiera a 4 cassetti
- FG 119V/C73-3 cassetiera a 3 cassetti
- FG 119/BVF-L122B: base alta con frontalino apribile
- FG 119/KS: kit staffaggio



FG 119V/CO25

FG 119B/CO25

FG 119R/CO25



# ARREDAMENTO FURGONI



## FG 119V/CO33

€/LISTINO  
~~3.281,60~~

PROMO  
**1.599,00€**

### CONFIGURAZIONE ARREDAMENTO TECNICO PER FURGONI

Dimensioni mm: 1470x400x1360

Peso kg: 114

Comprende (dall'alto verso il basso)

FG 119/M30-40: coppie di montanti laterali

FG 119/RP30-141: ripiano con divisori amovibili

FG 119/RV30-141: ripiano con vaschette in plastica

FG 119V/C49-V1: modulo dotato di 4 valigette portaminuterie

FG 119V/C98-3: cassetiera a 3 cassetti

FG 119V/BA98: base aperta

FG 119V/C49-5B: base con 5 cassetti

FG 119/RI98: rialzo per basi aperte o chiuse

FG 119/KS: kit staffaggio



FG 119V/CO33

FG 119B/CO33

FG 119R/CO33



## FG 119V/CO18

€/LISTINO  
~~1.968,00~~

PROMO  
**999,00€**

### CONFIGURAZIONE ARREDAMENTO TECNICO PER FURGONI

Dimensioni mm (LxPxH): 980x400x980

Peso kg: 56,5

Comprende (dall'alto verso il basso)

FG 119/98TL: piano di lavoro in legno

FG 119/C49-3: cassetiera a 3 cassetti

FG 119/C49-4: cassetiera a 4 cassetti

FG 119V/BA98: base aperta

FG 119/RI98: rialzo per basi aperte o chiuse

FG 119/KS: kit staffaggio



FG 119V/CO18

FG 119B/CO18

FG 119R/CO18



**FG 119V/CO27**

€/LISTINO  
~~2.070,00~~

**PROMO**  
**1.099,00€**

**CONFIGURAZIONE ARREDAMENTO TECNICO PER FURGONI**

Dimensioni mm (LxPxH): 1225x400x980

Peso kg: 71,6

Comprende (dall'alto verso il basso)

FG 119/73TL: piano di lavoro in legno

FG 119/49TL: piano di lavoro in legno

FG 119/C49-4: cassetiera a 4 cassette

FG 119/C73-3: cassetiera a 3 cassette

FG 119/BVF-L122B: base alta con frontalino apribile

FG 119/KS: kit staffaggio



FG 119V/CO27

FG 119B/CO27

FG 119R/CO27

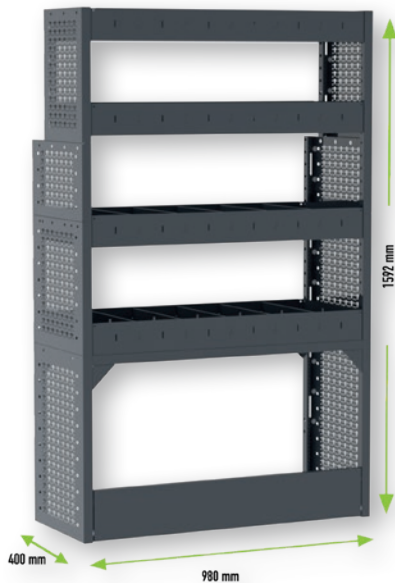

**FG 119M/CO13**

€/LISTINO  
~~1.274,40~~

**PROMO**  
**599,00€**

**CONFIGURAZIONE ARREDAMENTO TECNICO PER FURGONI**

Dimensioni mm (LxPxH): 980x400x1592

Peso kg: 38

Comprende (dall'alto verso il basso)

FG 119/M30-40: coppie montanti laterali

FG 119/RP30-92: ripiano con divisori amovibili

FG 119/RP30-92: ripiano con divisori amovibili

FG 119/M40-23: coppie montanti laterali

FG 119/M40-40: coppie montanti laterali

FG 119/RP40-92: ripiano con divisori amovibili

FG 119/RP40-92: ripiano con divisori amovibili

FG 119/BVF-L98B: base con frontalino apribile

FG 119/KS: kit staffaggio



**FG 119M/CO28**

€/LISTINO  
~~1.346,40~~

**PROMO**  
**699,00€**

**CONFIGURAZIONE ARREDAMENTO TECNICO PER FURGONI**

Dimensioni mm (LxPxH): 1225x400x1592

Peso kg: 47

Comprende (dall'alto verso il basso)

FG 119/M30-40: coppie montanti laterali

2 x FG 119/RP30-116: ripiani con divisori amovibili

FG 119/M40-23: coppie montanti laterali

FG 119/M40-40: coppie montanti laterali

2 x FG 119/RP40-116: ripiani con divisori amovibili

FG 119/BVF-L122B: base con frontalino apribile

FG 119/KS: kit staffaggio





**AUTOMOTIVE**



**FG 178/UF**

€/LISTINO  
~~60,00~~

**PROMO**  
**35,90€**

IMBUTO UNIVERSALE PER OLIO



**FG 175/PR**

€/LISTINO  
~~40,00~~

**PROMO**  
**23,90€**

PROLUNGA PER CHIAVI A BUSSOLA PER TAPPI OLIO

Dotata di contenitore di raccolta olio  
Attacco 3/8" - 1/2"  
Capacità 1200 cc



**FG 175/S30**

€/LISTINO  
~~221,50~~

**PROMO**  
**129,00€**

SET 28 CHIAVI A TAZZA PER FILTRI OLIO



**FG 175PF/S4**

€/LISTINO  
~~76,50~~

**PROMO**  
**45,90€**

SET 4 CHIAVI A TAZZA PER FILTRI OLIO - MOD. PURFLUX



**FG 178/UF83**

€/LISTINO  
~~35,00~~

**PROMO**  
**19,90€**

CHIAVE AUTOSERRANTE PER SMONTAGGIO FILTRI OLIO

3/8"

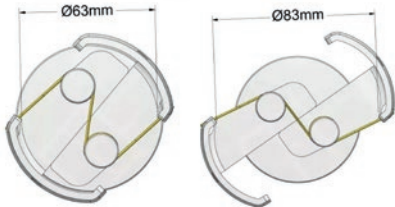

1/2"

CHIAVE AUTOSERRANTE PER FILTRI OLIO PER SERRAGGI DESTORSI E SINISTRORSI - MODELLO PESANTE

CODICE	ØMM	€/LISTINO	€/PROMO
FG 178/UF110	80 - 110 mm	115,00	69,00€
FG 178/UF145	104 - 145 mm	165,00	99,00€

**FG 175/S15**

€/LISTINO  
~~135,00~~

**PROMO**  
**79,90€**

SET 15 CHIAVI A BUSSOLA MAGNETICHE PER TAPPI OLIO

Esagono maschio 8, 10, 12, 14, 17 mm  
Esagono femmina 13, 14, 17, 18, 19, 21 mm  
Torx TX45



**FG 178/FL**

€/LISTINO  
~~45,50~~

**PROMO**  
**26,90€**

IMBUTO FLESSIBILE IN ALLUMINIO RIVESTITO IN GOMMA

Flessibile e modellabile, per facilitare il riempimento e lo svuotamento dei liquidi  
L/mm 370  
L1/mm 170



**FG 175/S4**

€/LISTINO  
~~72,50~~

**PROMO**  
**39,90€**

SET UTENSILI PER SMONTAGGIO TAPPI OLIO IN PLASTICA

Adatto per VAG TFSI E TDI, FORD, BMW, CITROEN/PEUGEOT



**FG 175/S114**

€/LISTINO  
~~220,00~~

**PROMO**  
**129,00€**

SET RIPARAZIONE TAPPI OLIO

- M 13x1.25
- M 13x1.5
- M 15x1.5
- M 17x1.5
- M 20x1.5
- M 22x1.5



**FG 202/PV**

€/LISTINO  
~~230,00~~

**PROMO**  
**139,00€**

POMPA DI PRESSIONE E DEPRESSIONE



**FG 203/S20**€LISTINO  
~~370,00~~**PROMO**  
**219,00€****KIT CONTROLLO TENUTA IMPIANTO DI RAFFREDDAMENTO****FG 201/S7**€LISTINO  
~~340,00~~**PROMO**  
**199,00€****SET RIPRISTINO PRESSIONE CIRCUITO CARBURANTE SISTEMI DIESEL**

Nuovo modello con pompa bi-direzionale

**FG 176/S13**€LISTINO  
~~445,00~~**PROMO**  
**269,00€****POMPA PER INSERIMENTO OLIO CAMBI E DIFFERENZIALI MANUALI E AUTOMATICI**

Fornito di 12 accessori per connessione diretta

Dotato di valvola di non ritorno

Capacità 7.5l

**TAPPI OPTIONAL PER FG 203/S20**FG 203/BW1  
BMWFG 203/FO1  
FORD Fiesta  
from 2008FG 203/FO2  
FORDFG 203/OP1  
OPELFG 203/TO1  
TOYOTAFG 203/FT1  
FIAT

CODICE	MARCA	€/LISTINO	€/PROMO
FG 203/BW1	BMW	37,50	22,90€
FG 203/FO1	FORD FIESTA dal 2008	37,50	22,90€
FG 203/FO2	FORD FIESTA	37,50	22,90€
FG 203/FT1	FIAT	46,00	27,90€
FG 203/OP1	OPEL	37,50	22,90€
FG 203/TO1	TOYOTA	37,50	22,90€

**FG 203/S7**€LISTINO  
~~166,00~~**PROMO**  
**99,00€****STRUMENTO PER IL RIEMPIMENTO A DEPRESSIONE DEI CIRCUITI DI RAFFREDDAMENTO**

Utile per effettuare uno spurgo perfetto grazie alla messa sotto vuoto del circuito di raffreddamento

**FG 491/200**€LISTINO  
~~32,00~~**PROMO**  
**22,90€****SIRINGA PER OLIO E FLUIDI**

Fornita con 2 guarnizioni di ricambio - Capacità 200cc

**FG 491/1500**€LISTINO  
~~85,00~~**PROMO**  
**51,90€****SIRINGA PER OLIO E FLUIDI**

Fornita con 2 guarnizioni di ricambio

Non adatta per carburanti e olii minerali - Capacità 1500cc

**FG 491/DF1500**€LISTINO  
~~135,00~~**PROMO**  
**79,90€****SIRINGA PER ESTRAZIONE CARBURANTE DEL CIRCUITO DIESEL**

Dotata di adattatori a innesto rapido - Capacità 1500cc



**FG 191/S22**

€/LISTINO  
~~620,00~~

**PROMO**  
**369,00€**

SET UNIVERSALE PER ESTRAZIONE ELETTRO-INIETTORI BOSCH, DELPHI, SIEMENS E DENSO  
Completo di massa battente 4.8 kg



**FG 191/S24**

€/LISTINO  
~~460,00~~

**PROMO**  
**279,00€**

SET UTENSILE PNEUMATICO PER ESTRAZIONE ELETTRO-INIETTORI BOSCH, DELPHI, SIEMENS E DENSO



**FG 190/RI**

€/LISTINO  
~~58,00~~

**PROMO**  
**34,90€**

ESTRATTORE PER RONDELLE INIETTORI



**FG 190/RE**

€/LISTINO  
~~180,00~~

**PROMO**  
**99,00€**

ESTRATTORI INIETTORI DIESEL M9R - RENAULT/OPEL/NISSAN



**FG 190/IP**

€/LISTINO  
~~48,00~~

**PROMO**  
**28,90€**

UTENSILE PER ESTRAZIONE UGELLO ELETTRO-INIETTORI



**FG 190/OP**

€/LISTINO  
~~45,00~~

**PROMO**  
**26,90€**

ESTRATTORE INIETTORI OPEL MOTORI BENZINA AD INIEZIONE DIRETTA



**FG 190/S8**

€/LISTINO  
~~80,00~~

**PROMO**  
**49,00€**

KIT ESTRAZIONE INIETTORI BMW N54/MINI N14



**FG 191/S14**€LISTINO  
~~155,00~~**PROMO**  
**95,00€****KIT PER PULIZIA SEDI INIETTORI**  
In valigetta ABS**CODICE**

FG 191/S14-2	1- Asta filettata M5X0.8XL200mm
FG 191/S14-3	2- Tappo chiusura sede iniettore
FG 191/S14-4	3- Spazzola lunga per la pulizia della sede iniettore
FG 191/S14-1	4- Prolunga flessibile
FG 191/S14-6	5- Spazzola a tazza Ø 15
FG 191/S14-7	6- Spazzola a tazza Ø 20
FG 191/S14-8	7- Spazzola Ø 24x85L
FG 191/S14-9	8- Spazzola Ø 18x85L
FG 191/S14-10	9- Spazzola Ø 21x85L

**FG 190/S6B**€LISTINO  
~~165,00~~**PROMO**  
**99,00€****SET PER FRESATURA SEDI INIETTORI**  
In valigetta ABS**FG 174/SC**€LISTINO  
~~118,50~~**PROMO**  
**72,90€****CHIAVE REGOLABILE PER GHIERE GALLEGGIANTI SERBATOIO CARBURANTE**  
Ømm: 88-170**FG 182/S16**€LISTINO  
~~510,00~~**PROMO**  
**309,00€****SET ESTRAZIONE CANDELETTE SPEZZATE**  
In valigetta ABS**PUNTE PER FORARE IN TITANIO****CONO DI CENTRAGGIO/ESTRATTORE IN ACCIAIO****FG 183/S5**€LISTINO  
~~115,00~~**PROMO**  
**69,00€****SET CHIAVI A BUSSOLA PER CANDELETTE PRERISCALDAMENTO MOTORI DIESEL**  
Contenuto: 8,9,10,12,14mm**FG 181RE/S2**€LISTINO  
~~86,00~~**PROMO**  
**49,90€****SET 2 CHIAVI A BUSSOLA EXTRA-LUNGHE POLIGONALI PER RIMOZIONE CANDELE D'ACCENSIONE**  
Contenuto: 14, 16mm**FG 181/C14**€LISTINO  
~~32,50~~**PROMO**  
**19,90€****CHIAVE A BUSSOLA SNODATA PER CANDELE D'ACCENSIONE BMW**  
Ø 14mm

**FG 179/SF**

€/LISTINO  
~~1.820,00~~

**PROMO**  
**929,00€**

**APPARECCHIO SPURGO LIQUIDO FRENI 12V**

- Alimentazione 12V con cavi batteria
- Vano serbatoio con anta porta tappi e 2 mensole porta oggetti posteriori
- Indicatore livello liquido freni a 3 led
- Adatto per liquido freni tipo DOT3, DOT4, DOT5.1
- Pressione massima 2 Bar - Portata 2 l/min
- 4 ruote (due girevoli, 1 con freno)
- In dotazione:
  - 4 bottiglie di recupero liquido freni con tappo e catena con gancio
  - Tubo trasparente con adattatore in gomma (4 m)
  - 10 tappi diversi in base alle applicazioni
    - tappo conico
    - tappi con meccanismo a baionetta (5, 8, 2)
    - tappi con meccanismo con filettatura (I2, F2, D2, E2, G2, M2)



**NEW**  
CE

**10 TAPPI IN DOTAZIONE**

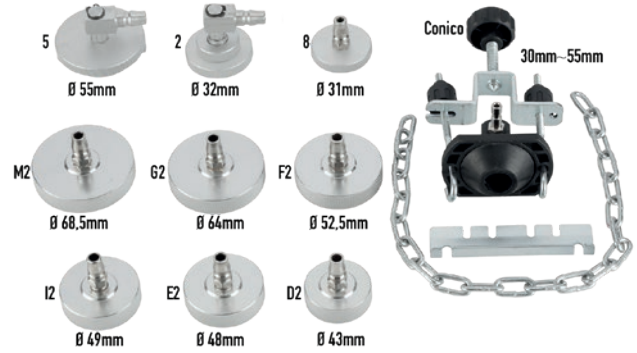

**4 BOTTIGLIE DI RECUPERO LIQUIDO FRENI CON TAPPO E SISTEMA A CATENA**



**VANO SERBATOIO CON ANTA PORTA TAPPI**



**INDICAZIONE LIVELLO LIQUIDO FRENI A 3 LED**



**GANCI PORTA TUBI 4 RUOTE (2 GIREVOLI, 1 CON FRENO)**

**FG 178/BF**

€/LISTINO  
~~255,00~~

**PROMO**  
**149,00€**

**ASPIRATORE PNEUMATICO PER LIQUIDO FRENI**

- Dotato di sonde e attacchi universali
- Capacità 2 litri



**FG 178/S6**

€/LISTINO  
~~330,00~~

**PROMO**  
**189,00€**

**SET TAPPI PER VEICOLI ASIATICI**

Toyota, Hyundai, Nissan, Mitsubishi, Mazda, Subaru, Honda, Suzuki



**FG 199/PF**€LISTINO  
~~230,00~~**PROMO**  
**139,00€****SET ARRETRATORE PNEUMATICO PER PISTONCINI FRENI A DISCO**  
Per destrorsi e sinistrorsi**FG 172/BS**€LISTINO  
~~220,00~~**PROMO**  
**129,00€****DIVARICATORE AD ARIA COMPRESSA PER CUFFIE SEMIASSI**Per giunti con diametro compreso tra 25 mm e 110 mm  
Struttura interna rinforzata in acciaio  
Pressione massima 9 bar  
Pressione raccomandata 5 ÷ 8 bar  
Dimensione minima del tubo aria 3/8"  
Attacco aria 1/4"**NEW****FG 628/S7**€LISTINO  
~~115,00~~**PROMO**  
**69,00€****SET 3 BUSSOLE PER CERCHI IN LEGA LEGGERA CON ADATTATORI PER BULLONI DANNEGGIATI**  
17, 19, 21mm

1/2"

**FG 186P/S4**€LISTINO  
~~24,50~~**PROMO**  
**14,90€****SET 4 LEVE IN NYLON****FG 198/PE**€LISTINO  
~~60,00~~**PROMO**  
**35,90€****PINZA PER RIMOZIONE PESI ADESIVI EQUILIBRATURA RUOTE****CHIAVE A BUSSOLA RINFORZATA PER DADI BULLONI**

1/2"

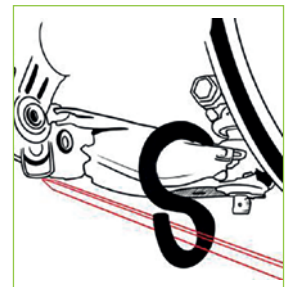
**FG 125/LV**€LISTINO  
~~20,50~~**PROMO**  
**11,90€****GANCIO LEVA UNIVERSALE PER ASSALI**Per montaggi e smontaggi semplici e sicuri di parti dell'asse.  
Grazie al suo speciale design può essere inserito molto vicino alla sospensione  
L/mm 103 - L1/mm 88 - L2/mm 38 - L3/mm 25

CODICE	MM	APPLICAZIONE	€/LISTINO	€/PROMO
FG 628/R17.5	16.5x17.5	FIAT, JEEP	€ 21,00	€ 12,90
FG 628/R18.5	18.5x19.5	FORD	€ 21,00	€ 12,90
FG 628/R21.5	21x21.5	FORD GALAXY, VOLVO, TOYOTA	€ 23,00	€ 13,90
FG 628/R22.5	22x22.5	CHRYSLER DODGE, LAND ROVER, RANGE ROVER	€ 23,00	€ 13,90
FG 628/R27.5	27x27.5	LAND ROVER DISCOVERY, RANGE ROVER	€ 26,00	€ 15,90

**FG 125/SB**

€/LISTINO  
~~65,00~~

**PROMO**  
**39,00€**

**UTENSILE SEPARATORE PER BRACCETTI OSCILLANTI**

Meccanismo di funzionamento a leva tramite scorrevoli, cricchetti o chiavi da inserire in uno dei tre attacchi quadri da 1/2" presenti sull'utensile  
Perni con rivestimento antiscivolo per una maggiore sicurezza

**NEW**

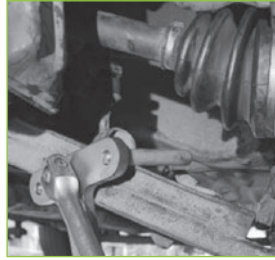

**FG 198/DF**

€/LISTINO  
~~370,00~~

**PROMO**  
**219,00€**

**ESTRATTORE CON VITE IDRAULICA PER MOZZI E CUSCINETTI RUOTE 3,4,5 FORI**

Piastra a 10 fori  
Per mozzi fino a M12



**FG 198/S11**

€/LISTINO  
~~138,00~~

**PROMO**  
**82,90€**

**SET 11 UTENSILI PER SMONTAGGIO BULLONI PINZE FRENO**

Audi, BMW, Ford, Mercedes Benz, Porsche, Volkswagen



**FG 168/GA**

€/LISTINO  
~~65,00~~

**PROMO**  
**38,90€**

**UTENSILE DIVARICATORE UNIVERSALE**

Elevata capacità (5 - 11,5 mm)  
Utilizzo universale  
Superfici di pressione parallele



**FG 159/PM**

€/LISTINO  
~~230,00~~

**PROMO**  
**139,00€**

**SET PRESSORI PER AMMORTIZZATORI**

Dotato di 2 coppie di barre filettate  
L/mm barre: 65-200/65-370



**FG 165/S26**

€/LISTINO  
~~700,00~~

**PROMO**  
**429,00€**

**SET UTENSILI SPECIALI PER MONTAGGIO/SMONTAGGIO SILENT BLOCK**

Boccole per Ø 44-82mm  
4 barre filettate M10, M12, M14, M16



**FG 166/S28**

€/LISTINO  
~~475,00~~

**PROMO**  
**279,00€**

**SET PER MONTAGGIO/SMONTAGGIO CUSCINETTI RUOTA**

Smontaggio Ø 34-45mm  
Montaggio Ø 60-84mm

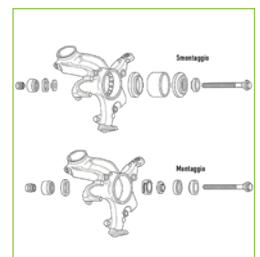

**FG 198/S7**

€/LISTINO  
~~82,00~~

**PROMO**  
**49,90€**

**SET 6 SPAZZOLE MOZZI RUOTA CON ADATTATORE**

3 spazzole Ø/mm 16  
3 spazzole Ø/mm 14

**NEW**

1/2"





## FG 98/B

€/LISTINO  
~~580,00~~

PROMO  
**349,00€**

### AVVIATORE DI EMERGENZA PORTATILE 12V, 22AH

Per avviamento di soccorso di veicoli con batterie da 12V  
Batteria al piombo tipo AGM con capacità da 22Ah

Corrente di avviamento 800A

Corrente di spunto 2200A

Cavi 2 AWG in puro rame lunghi 1,65 metri

Pinze da 1000A con manico in ABS per la massima comodità d'uso

Display LCD multifunzione

Led per indicazione della percentuale di carica e della tensione della batteria

Fusibile di protezione da 500A sul cavo della pinza rossa con funzione test integrità

Alert inversione della polarità

Luce led per illuminare l'area di lavoro anche durante le ore notturne

Prese di emergenza: accendisigari 12V DC 15A e USB 5V 2,4A (power bank)

Caricabatterie da muro in dotazione



CAVI 2AWG IN PURO RAME  
DA 1,65M



FUNZIONE POWER BANK



CARICABATTERIE IN  
DOTAZIONE

CE **CORRENTE  
DI SPUNTO  
2200A** **11,9kg**

## FG 98/C

€/LISTINO  
~~1.150,00~~

PROMO  
**699,00€**

### AVVIATORE DI EMERGENZA PORTATILE 12/24V, 44AH

Per avviamento di soccorso di veicoli e veicoli commerciali con batterie da 12V o 24V  
Ideale per auto, veicoli commerciali, imbarcazioni, mezzi agricoli, generatori, ecc.

2 batterie al piombo tipo AGM con capacità 22Ah ciascuna

Corrente di avviamento: 1600A a 12V; 800A a 24V

Corrente di spunto: 4400A a 12V; 2200A a 24V

Cavi 1AWG in puro rame, lunghi 1,65 metri

Pinze da 1000A con manico in ABS per la massima comodità d'uso

Display LCD multifunzione

Alert inversione della polarità

Led per indicazione della percentuale di carica e della tensione della batteria

Sistema elettronico di protezione della batteria interna

Luce led per illuminare l'area di lavoro anche durante le ore notturne

Prese di emergenza: accendisigari 12V DC 15A e USB 5V 2,4A (power bank)

Caricabatterie da muro in dotazione

**CORRENTE DI SPUNTO  
4400A - 2200A** **19,9kg**



LUCI LED DISPLAY LCD



CAVI 1AWG IN PURO RAME  
DA 1,65M



CARICABATTERIE IN  
DOTAZIONE

CE **CORRENTE  
DI SPUNTO  
2200A** **11,9kg**

## FG 97/LT

€/LISTINO  
~~250,00~~

PROMO  
**149,00€**

### AVVIATORE PORTATILE MULTIFUNZIONE

Adatto per l'avviamento di emergenza di motori con batteria da 12V

Display LCD - Led con 5 modalità - 2 uscite USB 5V 2,4A

Cavo 12V 10A per presa accendisigari in dotazione

3 modalità di ricarica (in dotazione: caricabatterie, cavo USB tipo C, adattatore 14V 1A per presa accendisigari)

Funzione Power Bank - Funzione Travel Lock

In dotazione boost con morsetti per avviamento motore, custodia



**CORRENTE  
DI SPUNTO  
800A** **CAPACITÀ  
BATTERIA  
18000mAh**

**SISTEMA ELETTRONICO  
DI PROTEZIONE DELLA BATTERIA INTERNA**



**FG 98/A1.5**

€LISTINO  
~~66,00~~

**PROMO**  
**39,90€**

**CARICABATTERIE E MANTENITORE DI CARICA 6/12V**

Utilizzabile con batterie AGM, STD, GEL, LFP da 6 o 12V

3 led indicatori dello stato di carica

Protezione da surriscaldamento, inversione di polarità, cortocircuito, sovraccarico

In dotazione cavi con pinze e cavi con occhielli

Dimensioni 110x63x35mm - Peso 0,298kg

**NEW**



CE



MAX CORRENTE DI CARICA  
**1.5A**

**FG 98/A25**

€LISTINO  
~~330,00~~

**PROMO**  
**199,00€**

**CARICABATTERIE E MANTENITORE DI CARICA 12/24V**

Utilizzabile con batterie AGM, LIQ, GEL, LFP da 12 o 24V

Display LCD

Pannello di controllo

Funzione Boost per la ricarica rapida (35A a 12V, 20A a 24V)

Funzione test alternatore

Protezione da sovraccarico e inversione di polarità

In dotazione cavi con pinze

Dimensioni mm 250x130x80 - Peso 1,650kg

**NEW**



CAPACITÀ DI CARICA  
**10-300Ah**

MAX CORRENTE DI CARICA  
**25A (12V) - 12A (24V)**



CE



**FG 98/A5**

€LISTINO  
~~120,00~~

**PROMO**  
**69,90€**

**CARICABATTERIE E MANTENITORE DI CARICA 6/12V**

Utilizzabile con batterie AGM, LIQ, GEL, LFP da 6 o 12V

Display LCD con pannello di controllo

Protezione da sovraccarico e inversione di polarità

In dotazione cavi con pinze e cavi con occhielli

Dimensioni 170x85x45mm - Peso 0,515kg

**NEW**



CE



MAX CORRENTE DI CARICA  
**2.5A (6V) - 5A (12V)**

CAPACITÀ DI CARICA  
**5-80Ah**

**FG 98/A160**

€LISTINO  
~~1.400,00~~

**PROMO**  
**849,00€**

**CARICABATTERIE E MANTENITORE DI CARICA MULTIFUNZIONE 12V**

Utilizzabile con batterie AGM, STD, EFB, GEL, LFP 12V

Display LCD

Pannello di controllo

Funzione test alternatore

Funzione di recupero batterie scariche

Protezione da sovraccarico, inversione di polarità, surriscaldamento, cortocircuito

In dotazione cavi con pinze

Dimensioni mm 270x390x105 - Peso 2kg

**NEW**

CE



CORRENTE DI CARICA  
**10/20/50/80/120/160A**

CAPACITÀ DI CARICA  
**14-2000Ah**

**FG 98/A15**

€LISTINO  
~~280,00~~

**PROMO**  
**169,00€**

**CARICABATTERIE E MANTENITORE DI CARICA 6/12/24V**

Utilizzabile con batterie sia al piombo acido che al litio

Display LCD

8 fasi di ricarica

Funzione WINTER (ciclo di carica ottimizzato in presenza di basse temperature)

Funzione JUMP (ricarica per batterie molto scariche)

Indicatore del livello di carica

Identificazione delle batterie esauste

Funzione di recupero batterie scariche per batterie al piombo acido

Protezione da surriscaldamento, inversione di polarità, cortocircuito, sovraccarico

In dotazione cavi con pinze

Dimensione 200x120x70 mm - Peso 1,3Kg



MAX CORRENTE DI CARICA  
**15A (6V e 12V) - 8A (24V)**

CAPACITÀ DI CARICA  
**max 150Ah**



CE





**FG 215/S40**

€/LISTINO  
~~1.550,00~~

PROMO  
**879,00€**

**TESTER PROVA COMPRESIONE DIGITALE CON FINTE INIETTORI E FINTE CANDELETTE PER SISTEMI DIESEL**

Grado di precisione: 1%FS  
Software in 8 lingue (IT, EN, DE, FR, ES, PT, GR, PL)  
Display touch screen LCD retroilluminato a colori 4.3"  
Dotazione:  
Sensore di pressione 0-80 Bar  
Morsetti di collegamento a batteria 12V  
Kit raccordi e tubo per sistemi Benzina  
Kit raccordi e tubo per sistemi Diesel



ACCESSORI DI BASE IN DOTAZIONE



PROVA ALTERNATORE  
PROVA TENSIONE BATTERIA



PROVA COMPRESIONE



**IDEATO, INGEGNERIZZATO  
E INTERAMENTE PRODOTTO IN ITALIA**

**FG 219/S**

€/LISTINO  
~~3.350,00~~

PROMO  
**1.999,00€**

**TESTER MULTI-FUNZIONE PER PROVA COMPRESIONE PROVA PRESSIONE CARBURANTI E PRESSIONE OLIO MOTORE**

Grado di precisione: 1%FS  
Software in 8 lingue (IT, EN, DE, FR, ES, PT, GR, PL)  
Display touch screen LCD retroilluminato a colori, 4.3"  
Dotazione:  
Sensori di pressione 0-80 Bar e 0-2.500 Bar;  
Morsetti di collegamento a batteria 12V;  
Kit raccordi e tubo per sistemi Benzina;  
Tubazione per attacchi sistemi Diesel



PROVA ALTERNATORE  
PROVA TENSIONE BATTERIA



PROVA COMPRESIONE



PROVA PRESSIONE CARBURANTE  
(ALTA E BASSA)



PROVA OLIO MOTORE



**POSSIBILITÀ DI MEMORIZZARE E SCARICARE LE PROVE SU PC, PERSONALIZZANDO LA SCHEDA DATI CON TUTTE LE INFORMAZIONI DEL CLIENTE.**

**FG 220/BT**

€LISTINO  
~~429,00~~

**PROMO**  
**249,00€**

**TESTER DIGITALE PER BATTERIE 12V E 24V**

Tensione di funzionamento: da 9V a 35V DC  
Tempo di verifica della batteria: circa 1 minuto  
Batteria interna per memoria data/ora: CR1220 (1 pezzo)  
Dimensioni: 90x50x235mm



CARATTERISTICHE:	DISPLAY RETROILLUMINATO
	SOFTWARE 6 LINGUE: italiano; inglese; spagnolo; polacco; tedesco; francese
	STAMPANTE INTEGRATA CON ROTOLO DI CARTA TERMICA
	SISTEMA RILEVAZIONE FALSO CONTATTO COLLEGAMENTO PINZE
APPLICAZIONI:	TEST BATTERIE 12 E 24V
	TEST ALTERNATORE (INTELLIGENTE E NORMALE) 12-24V CARICA
	TEST SISTEMA DI AVVIAMENTO
BATTERIE SUPPORTATE:	PB, WET, GEL AGM, AGM FLAT, EFB
APPLICAZIONI:	CCA: 100-1700; IEC: 100-1000; EN: 100-1700; DIN: 100-1000; JIS
LUNGHEZZA DEI CAVI:	570 mm

**FG 220/EN**

€LISTINO  
~~459,00~~

**PROMO**  
**259,00€**

**VIDEOSCOPIO DIGITALE CON SONDA FLESSIBILE ED ORIENTABILE**

Sonda lunga 1 metro ed orientabile a 360° per la massima flessibilità  
Diametro della sonda 5,5 mm per accedere anche ai punti più stretti e difficili da raggiungere  
Display LCD da 4.3" per immagini chiare e dettagliate con un'elevata precisione  
Sonda progettata per resistere alle condizioni più difficili (temperatura di utilizzo da -10° a 50°)  
Angolo di visione 90°  
Profondità di campo visivo 15 – 100 mm  
Risoluzione massima Full HD 1920x1080 pixel  
Batteria integrata al litio da 3.7V - 2600mAh  
Autonomia della batteria fino a 4 ore  
Tempo di ricarica 4 ore  
Fornito in custodia di nylon semirigida  
In dotazione scheda SD da 32gb, cavo USB-C e due panni per la pulizia lente e display  
Dimensioni mm 220x123x48  
Peso 364 gr



FORNITO IN CUSTODIA DI NYLON SEMI-RIGIDA

DISPLAY LCD DA 4,3"

**VIDEOSCOPIO DIGITALE**

**ISPEZIONE E MANUTENZIONE DI MACCHINARI ED IMPIANTI**

**SONDA CON ILLUMINAZIONE A 6 LED REGOLABILE SU 3 MODALITÀ**

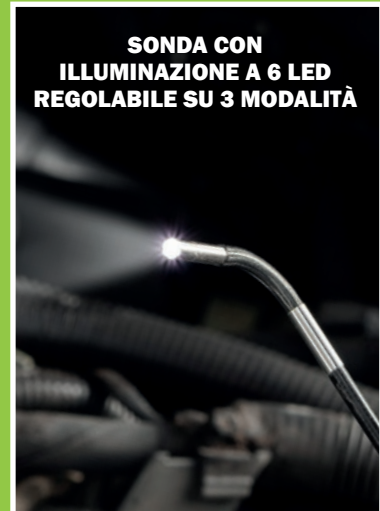

SCOPRI DI PIÙ

**IN DOTAZIONE SCHEDA SD DA 32 GB PER REGISTRARE E ARCHIVIARE IMMAGINI, VIDEO E AUDIO**

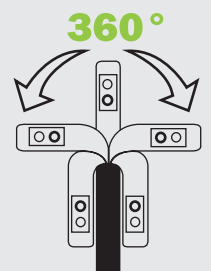

**SONDA LUNGA 1 metro ORIENTABILE A 360° PER LA MASSIMA FLESSIBILITA'**

**SONDA 5,5mm**

**FG 179/ST**

€/LISTINO

~~25,00~~**PROMO  
14,90€****CHIAVE A BUSSOLA PER INSTALLAZIONE/RIMOZIONE SISTEMA START-STOP GRUPPO PSA**

Attacco quadro 1/2"

Speciale profilo anteriore triangolare

Per veicoli Peugeot e Citroen con tecnologia micro-ibrida e-HDi

**NEW**

1/2"

**FG 172/AS2**

€/LISTINO

~~113,00~~**PROMO  
69,00€****PINZA PER ANELLI STRINGITUBO CON PROLUNGA INTERCAMBIABILE**  
Apertura mm 3-52**FG 172/FA**

€/LISTINO

~~72,50~~**PROMO  
41,90€****PINZA PER FASCETTE A SCATTO CLIC****FG 172/TC**

€/LISTINO

~~35,00~~**PROMO  
19,90€****PINZA RIMOZIONE PIOLI CATENE****FG 172/PA**

€/LISTINO

~~72,00~~**PROMO  
43,90€****PINZA PER SERRAGGIO E TAGLIO FASCETTE A NASTRO IN ACCIAIO INOX**

Indicata anche per fascette Panduit

Ømm 4.7 - 9.5

**FG 172/TG**

€/LISTINO

~~49,50~~**PROMO  
21,90€****PINZA PER RIMOZIONE TUBI ACQUA E CARBURANTE****FG 172/MA**

€/LISTINO

~~98,00~~**PROMO  
59,90€****PINZA PER FASCETTE A MOLLE**

Con ganasce multipresa regolabili

**FG 181/PM2**

€/LISTINO

~~93,00~~**PROMO  
54,90€****ESTRATTORE UNIVERSALE PER PULEGGE**

**FG 171/FL**

€/LISTINO  
~~52,00~~

**PROMO**  
**29,90€**

PINZA RACCORDI RAPIDI TUBO CARBURANTE CON TESTA FLESSIBILE



**FG 171/N**

€/LISTINO  
~~30,00~~

**PROMO**  
**17,90€**

PINZA RACCORDI RAPIDI TUBO CARBURANTE



**FG 184/S5**

€/LISTINO  
~~162,00~~

**PROMO**  
**99,00€**

SET 5 CHIAVI PER DADI TENDICINGHIA  
13,15,16,17,19mm



**FG 172/RL2**

€/LISTINO  
~~25,00~~

**PROMO**  
**14,90€**

PINZA PER ESTRAZIONE RELÉ  
Ømm 15-50



**FG 172/GO2**

€/LISTINO  
~~105,00~~

**PROMO**  
**63,90€**

PINZA PER COLLARI OETIKER



3/8"



**FG 172/OT**

€/LISTINO  
~~58,00~~

**PROMO**  
**33,90€**

PINZA PER COLLARI OETIKER



**FG 184/S4**

€/LISTINO  
~~92,00~~

**PROMO**  
**59,90€**

SET CHIAVI TENDICINGHIA

Per Gruppo VAG (1.8L - 2L benzina, 1.9L - 2L diesel), PSA (1.4L-1.5L-1.6L-2L-2.2L diesel), FCA (0.9L TwinAir benzina)

**NEW**



3/8"

**FG 172/CA**

€/LISTINO  
~~60,00~~

**PROMO**  
**35,90€**

PINZA PER CAPPUCCI CANDELE

Ømm: 14  
L/mm: 290

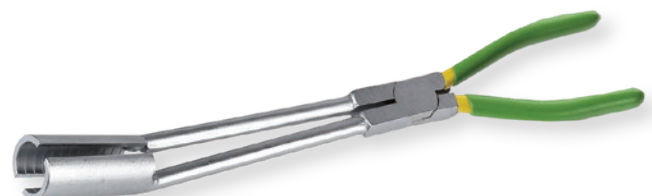



# SETTORE CARROZZERIA

## GLI STRUMENTI MIGLIORI, PER VERI PROFESSIONISTI

### FG 130AL/S5

€/LISTINO

~~37,50~~**PROMO  
22,90€**

#### KIT PUNZONI IN PLASTICA E BULINO IN ALLUMINIO

1 bulino in alluminio regolabile 70mm-100mm  
Filettatura M8x1.25

4 punzoni in gomma dura resistente agli urti e anti-graffio



### FG 130/S10

€/LISTINO

~~650,00~~**PROMO  
399,00€**

#### SET 10 UTENSILI PER CARROZZERIA

Contenuto: Spatole a cucchiaio e a cazzuola, tassi a rotaia, a virgola, a tacco e curvo, martelli con testa tonda e quadrata/a punta, mazzuola e porta lima con lima



### FG 184P/S3

€/LISTINO

~~27,00~~**PROMO  
15,90€**

#### SET 3 CUNEI IN PLASTICA

Materiale: Polipropilene ad alta resistenza



### FG 185P/S4

€/LISTINO

~~29,50~~**PROMO  
17,90€**

#### KIT 4 LEVE PER PARTI IN PLASTICA

Materiale: Nylon e fibra di vetro  
Elevata resistenza alla torsione  
Dotate di foro per appendimento

### FG 188/P1

€/LISTINO

~~21,00~~**PROMO  
12,90€**

#### LEVA PER PARTI IN PLASTICA

Materiale: Nylon e fibra di vetro  
Elevata resistenza alla torsione  
Dotata di foro per appendimento

### FG 188P/S2

€/LISTINO

~~43,00~~**PROMO  
25,90€**

#### KIT CUNEI PER RIMOZIONE MODANATURE IN PLASTICA

Materiale: Polipropilene ad alta resistenza  
1pz dotato di manico resistente alle percussioni  
1pz senza manico per ideale per spazi ristretti

**FG 184R/S3**

€LISTINO  
~~48,00~~

**PROMO**  
**28,90€**

SET 3 RASCHIETTI IN ACCIAIO CON MANICO IN ABS  
L1/mm 280  
L2/mm: 10,8 - 25 - 40

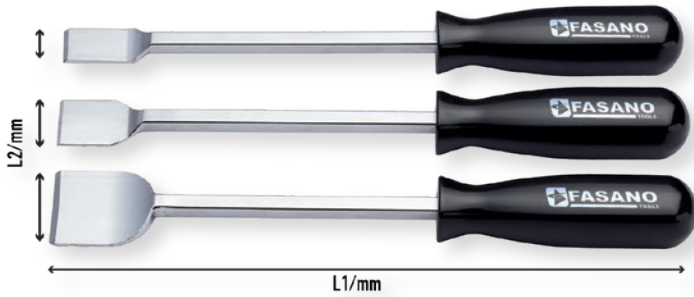

**FG 186P/S5**

€LISTINO  
~~37,50~~

**PROMO**  
**19,90€**

SET 5 LEVAPIOLI IN NYLON



**FG 184/R1**

€LISTINO  
~~22,00~~

**PROMO**  
**12,90€**

RASCHIETTO IN ACCIAIO CON MANICO IN ABS  
L1/mm 280  
L2/mm: 19

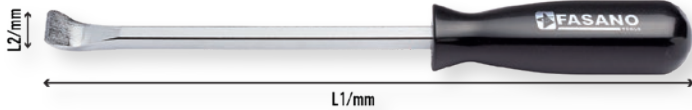

**FG 186/S5**

€LISTINO  
~~98,00~~

**PROMO**  
**59,90€**

SET 5 LEVAPIOLI CON LAMA IN ACCIAIO INOX



**FG 184/R2**

€LISTINO  
~~24,00~~

**PROMO**  
**13,90€**

RASCHIETTO IN ACCIAIO CON PROTEZIONE IN PVC E MANICO IN ABS  
L1/mm 275  
L2/mm: 25,6

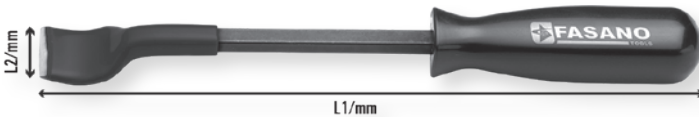

**FG 186/AL1**

€LISTINO  
~~26,00~~

**PROMO**  
**15,90€**

LEVA EXTRA PIATTA IN METALLO

Design unico della lama con un lato curvo ed uno dritto per la rimozione di elementi di fissaggio interni ed esterni anche negli spazi più stretti  
Punta sottile ad alta resistenza



**FG 185B/S2**

€LISTINO  
~~42,50~~

**PROMO**  
**25,90€**

SET 2 LEVAPIOLI CON MANICO IN ABS



**FG 185/S5**

€LISTINO  
~~98,00~~

**PROMO**  
**59,90€**

SET 5 LEVAPIOLI CON MANICO IN ABS  
Contenuto: FG 185/A1, FG 185/A2, FG 185/A6,  
FG 185/A7, FG 185/A8



**FG 186/S4**

€LISTINO  
~~27,50~~

**PROMO**  
**16,90€**

SET 4 UNCINI CON LAMA IN ACCIAIO  
Con impugnatura bimatereale



**FG 185/CR**€LISTINO  
~~11,50~~**PROMO**  
**6,90€****UTENSILE LEVA PER MOLLE A "C"**

Ideale per la rimozione delle molle a C presenti sulle manovelle alzavetro

**FG 185/RM**€LISTINO  
~~32,50~~**PROMO**  
**19,90€****UTENSILE PER RIMOZIONE MANIGLIA POGGIA MANO - GRUPPO VAG**Impugnatura in ABS  
L/mm 255**FG 185/OM**€LISTINO  
~~31,00~~**PROMO**  
**18,90€****UTENSILE PER RIMOZIONE CLIP OMEGA**

Per Gruppo VAG, Tesla, Mercedes-Benz (2008 ~ 2020)

Utilizzabile anche per rimuovere clip simili sul rivestimento del bagagliaio Tesla (Model Y) e sul rivestimento della portiera Tesla (Model Y)

**SET 3 LEVERINI IN MATERIALE PLASTICO**

CODICE		€/LISTINO	€/PROMO
FG 186/S3	3 LEVERINI	10,00	5,90€
FG 186/S3B	3 UNCINI	12,00	6,90€

**FG 189/PO1**€LISTINO  
~~23,00~~**PROMO**  
**13,90€****UTENSILE RIMOZIONE CILINDRETTO CHIUSURA PORTIERE - GRUPPO VAG****FG 183/RV1**€LISTINO  
~~22,00~~**PROMO**  
**12,90€****UTENSILE RIMOZIONE GUARNIZIONI VETRI**Impugnatura in ABS  
L/mm 252**UTENSILE RIMOZIONE SCHEGGE**Ideale per la pulizia del canale alzavetro  
Punta sferica per evitare danneggiamenti delle guide portiera

CODICE	L/MM	€/LISTINO	€/PROMO
FG 182/RG10	255	21,00	12,90€
FG 182/RG24	320	27,50	16,90€

**FG 189/PO2**€LISTINO  
~~41,00~~**PROMO**  
**24,90€****UTENSILE RIMOZIONE CILINDRETTO CHIUSURA PORTIERE - GRUPPO VAG**

**FG 183/CM**

€/LISTINO

~~51,50~~

**PROMO**  
**29,90€**

**COLTELLO MANUALE DOTATO DI CAVO E SISTEMA FERMA CAVO**

Impugnatura e cavo rivestito in PVC  
Fornito con una lama da 25mm già montata



**FG 183/RA1**

€/LISTINO

~~27,00~~

**PROMO**  
**15,90€**

**RASCHIETTO MANUALE A LAMA DRITTA**

Fornito con una lama in dotazione - Impugnatura in ABS dotata di foro per di appendamento  
Dotato di protezione lama in ABS



**COLTELLO MANUALE DOTATO DI LAMA INTERCAMBIABILE**

Fornito con una lama in dotazione - Impugnatura con rivestimento in PVC  
Sistema di bloccaggio lama a vite



CODICE	L/MM	€/LISTINO	€/PROMO
FG 183/CK250	250	22,00	12,90€
FG 183/CK450	450	35,00	19,90€
FG 183/CK600	600	44,00	24,90€

**FG 187/GR**

€/LISTINO

~~31,00~~

**PROMO**  
**18,90€**

**UTENSILE UNIVERSALE PER FISSAGGIO GUARNIZIONI**

Dotato di 6 accessori  
Sistema guida a rullo  
Impugnatura in ABS



**FG 187/GU**

€/LISTINO

~~29,50~~

**PROMO**  
**17,90€**

**LEVA BLOCCAFILO**

L1/mm: 345 - L2/mm: 145

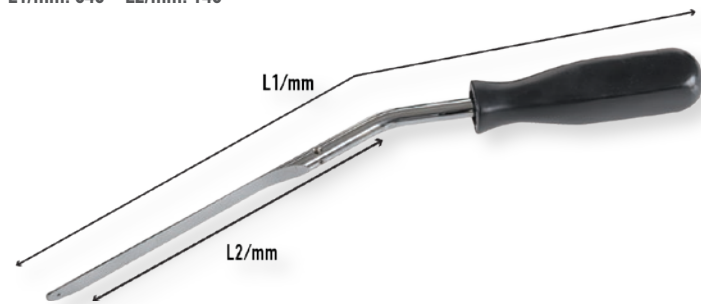

**FG 187/GU2**

€/LISTINO

~~29,50~~

**PROMO**  
**17,90€**

**GUIDAFILO A T CON IMPUGNATURA IN ABS**

L/mm: 320



**FG 187/S7**

€/LISTINO

~~216,50~~

**PROMO**  
**129,00€**

**SET 7 UTENSILI PER CRISTALLI AUTO**



**FG 187/K40**

€/LISTINO

~~196,00~~

**PROMO**  
**119,00€**

**VENTOSA SINGOLA DOTATA DI IMPUGNATURA E SISTEMA POMPANTE**

Capacità 40Kg  
Diametro: 178mm - 7"





## FG 187/S2

€LISTINO  
~~750,00~~

PROMO  
**459,00€**

### SET PER SMONTAGGIO PARABREZZA CON SISTEMA VENTOSE A CRICCHETTO

In valigetta di ABS

Ventose da 150mm con pompa manuale

Bobina di avvolgimento del filo da taglio con azionamento da 10mm (3/8")

Capacità massima di aspirazione: 50kg per ogni ventosa



**1.**  
Passare il filo taglia cristalli (consigliato FG 187/NY) dall'interno all'esterno dell'abitacolo, forando con un passafilo il sigillante vetro del parabrezza

**2.**  
Far passare il filo esternamente lungo il perimetro del parabrezza, nella fessura tra la scocca e il vetro, fissandolo in un punto di aggancio

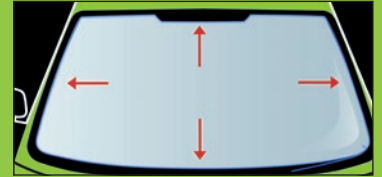

**3.**  
Procedere a installare le due ventose sul parabrezza usando la pompa manuale. Assicurarsi di arrivare fino alla scomparsa della linea rossa per ottenere la massima tenuta

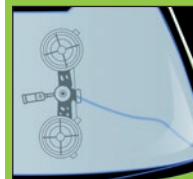

**4.**  
Inserire l'altro capo del filo nella puleggia e tendere il filo utilizzando un cricchetto. Per ottenere la massima tensione, utilizzare la terza ventosa in modo da mantenere sempre un angolo di 45° durante la trazione del filo

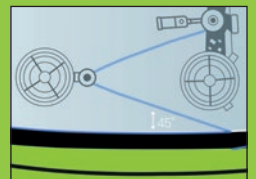

SCOPRI DI PIÙ

## FG 188P/S4

€LISTINO  
~~65,00~~

PROMO  
**39,90€**

### SET PROTEZIONE CRUSCOTTO CON MANIGLIA



## FG 165BC/S6

€LISTINO  
~~230,00~~

PROMO  
**139,00€**

### SET 6 ESTRATTORI PER BRACCI TERGICRISTALLO

1: VW, Porsche; 2: Ford, Seat, Mercedes; 3: BMW, VW; 4: Audi A3-A4-A5-A6; 5: VW, Opel, Honda; 6: Audi Q7



## FG 187/PN

€LISTINO  
~~263,00~~

PROMO  
**159,00€**

### TIRABOLLI PNEUMATICO, DOTATO DI 3 VENTOSE

Ventose: Ø/mm 130, 100, 80

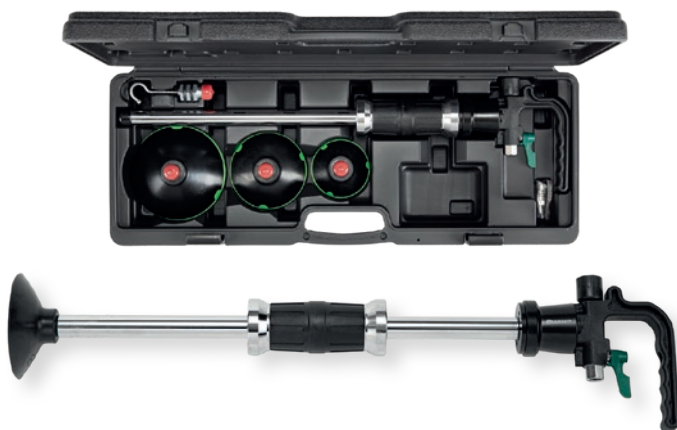

## FG 166/DS19

€LISTINO  
~~65,00~~

PROMO  
**39,90€**

## FG 166/DS24

€LISTINO  
~~65,00~~

PROMO  
**39,90€**

### DISPENSER PER NASTRO PER MASCHERATURA

Consente l'applicazione facile, veloce e precisa del nastro fissabile a parete tramite kit di fissaggio in dotazione



NEW

**FG 104V/AS284**

€LISTINO  
~~4.274,00~~

**PROMO**  
**1.599,00€**

**CARRELLO PORTA UTENSILI FG 104 A 7 CASSETTI  
CON ASSORTIMENTO 284 UTENSILI IN MODULI IN GOMMA  
PER CARROZZERIA**



**CODICE**

FG 104V/AS284	FG 104B/AS284	FG 104R/AS284	FG 104D/AS284
---------------	---------------	---------------	---------------

**ASSORTIMENTO 284 UTENSILI**

**1° CASSETTO**



- FG 100/03G: Modulo 14 chiavi combinate 6 - 19mm
- FG 100/17E: Modulo 65 utensili da 1/4"
- FG 100/21TX: Modulo 44 utensili TORX
- FG 100/45F: Modulo 6 giraviti a croce Phillips

**2° CASSETTO**



- FG 100/45I: Modulo 6 giraviti con impronta Torx
- FG 100/45T: Modulo 5 giraviti a bussola esagonali
- FG 100/56C: Modulo 4 utensili da percussione
- FG 100/81F: Modulo 27 inserti a bussola da 1/2" esagonali e XZN

**3° CASSETTO**



- FG 100/21M: Modulo 16 chiavi a bussola esagonali
- FG 100/39XT: Modulo 3 pinze assortite - serie Industrial
- FG 100/50G: Modulo 6 chiavi maschio Torx
- FG 100/68: Modulo 5 levapioli

**4° CASSETTO**



- FG 100/52A: Modulo 8 levapioli
- FG 100/52B: Modulo 26 utensili da taglio per carrozzeria
- FG 100/VA4: Modulo di riempimento con vani porta minuteria
- FG 100/52C: Modulo 5 utensili per cristalli veicoli

**5° CASSETTO**



- FG 100/52D: Modulo 10 leve in nylon
- FG 100/52E: Modulo 5 cunei in plastica
- FG 100/52F: Modulo 5 raschietti
- FG 100/52G: Modulo 5 utensili carrozzeria

**6° CASSETTO**



- FG 100/52H: Modulo utensili manutenzione carrozzeria
- FG 100/VA1: Modulo conv ani porta minuteria

**ASSORTIMENTO COMPLETO  
PER CARROZZERIA**





**UTENSILI ESSENZIALI PER AFFRONTARE  
LE NUOVE SFIDE DEL FUTURO**

# THE HYBRID REVOLUTION

**KIT 26 UTENSILI ISOLATI, CON ELMETTO DIELETTRICO  
E GUANTI DIELETTRICI 1000 V**  
Conforme alla normativa 1000V IEC 60900

**IDEALE PER INTERVENTI SU  
VEICOLI ELETTRICI ED IBRIDI**



FG 59/IS200



FG 61/IS200



FG 63/IS160



FG 603/E10,11,12,  
13,14,17,19



FG 625E/10,11,12,  
13,14,17,19



FG 22E/4X100, 5.5X125,  
FG22E/PH1X80, PH2X100



FG 625E/CR12



FG 625E/PR250



FG 49/E



FG 48/IS



FG 22/CF250



CODICE	TAGLIA GUANTI	€/LISTINO	€/PROMO
FG 603/S28A	Taglia 9	1.048,50€	559,00€
FG 603/S28B	Taglia 10	1.048,50€	559,00€

**FG 100V/AS56**

€/LISTINO  
~~2.743,00~~

**PROMO**  
**1.299,00€**

**CARRELLO MANUTENZIONE VEICOLI ELETTRICI E IBRIDI  
CON ASSORTIMENTO DI 56 UTENSILI ISOLATI**



**CODICE**

FG 100V/AS56	FG 100B/AS56	FG 100R/AS56	FG 100D/AS56	FG 100W/AS56
--------------	--------------	--------------	--------------	--------------

**ASSORTIMENTO 56 UTENSILI ISOLATI**  
Conforme alla norma 1000V IEC 60900



**1° CASSETTO**

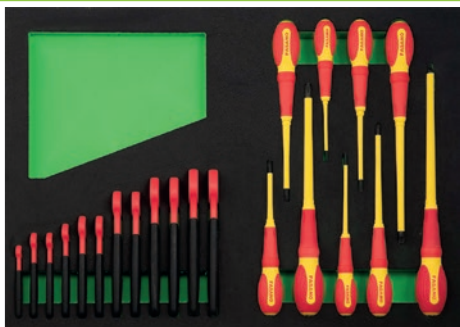

**FG 100/03-IS: Modulo chiavi a forchetta e giraviti isolati**  
-Chiavi a forchetta isolate 7-19mm  
-Giraviti isolati a taglio 2.5x75mm, 3x100mm, 5.5x125, 6.5x150mm, 8x175mm  
-Giraviti isolati per viti a croce Phillips PH0x60, PH1x80, PH2x100, PH3x150

**2° CASSETTO**



**FG 100/21-IS: Modulo bussole da 1/2" e accessori isolati**  
-Chiavi a bussola esagonali da 1/2" 10-32mm  
-Inseri a bussola esagonali corti e lunghi da 1/2" 4-10mm  
-Accessori da 1/2"

**3° CASSETTO**

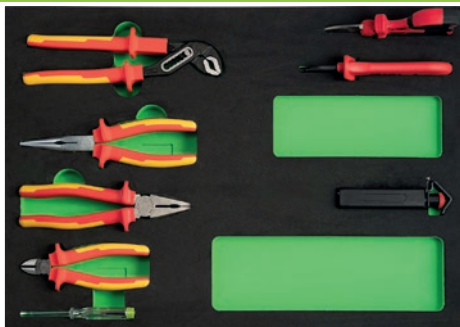

**FG 100/39-IS Modulo pinze e utensili da taglio isolati**  
-Pinze assortite e tronchese diagonale isolate  
-Forbice con manici isolati  
-Cutter professionale isolato  
-Spellacavi elicoidale



**FG 603/TA1**

€/LISTINO  
~~286,00~~

**PROMO**  
**149,00€**

**TAPPETO ISOLANTE 1.000V**  
Dimensioni 1.000 x 1.000 x 3mm  
Classe di isolamento 3  
Tensione di esercizio 26500 V  
Conforme alla norma IEC-EN 61111





# SMONTA AMMORTIZZATORI

DESIGN MIGLIORATO  
PER INCREMENTARE  
LA COMODITÀ E LA SICUREZZA  
DELL'OPERATORE  
DURANTE L'UTILIZZO

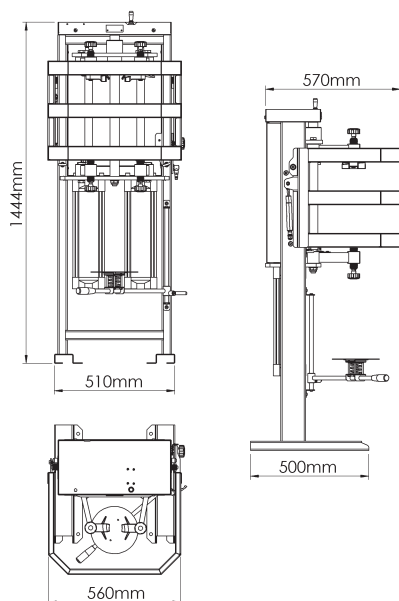

**NEW**

**+11 CM  
DI ALTEZZA  
PER LAVORARE  
CON MAGGIOR  
COMFORT**



**Nuovo meccanismo  
di sollevamento della gabbia  
con pistone a gas,  
per agevolare la manovra  
ed evitare l'abbassamento  
accidentale**



**Cavo di sicurezza che sostiene  
il pistone anche in caso di errato  
inserimento dell'ammortizzatore**



**Altezza della gabbia aumentata  
per una maggiore superficie di  
protezione**



**GRIFFE IN ACCIAIO  
C45 BONIFICATO,  
con opportuno  
trattamento termico,  
per una elevata  
resistenza meccanica**

**FG 750/1P**

€/LISTINO  
~~3.000,00~~

**PROMO**  
**1.599,00€**

**SMONTA-AMMORTIZZATORI DOTATO DI 1 PISTONE**  
Potenza spinta: 1.2 ton (10 bar) - 0.9 ton (8 bar)  
Corsa di compressione molla: 300mm



**FG 750/2P**

€/LISTINO  
~~3.700,00~~

**PROMO**  
**1.899,00€**

**SMONTA-AMMORTIZZATORI DOTATO DI 2 PISTONI**  
Potenza spinta: 2.4 ton (10 bar) - 1.9 ton (8 bar)  
Corsa di compressione molla: 300mm



**FG 752/1P**

€/LISTINO  
~~3.700,00~~

**PROMO**  
**1.799,00€**

**SMONTA-AMMORTIZZATORI DOTATO DI 1 PISTONE E DISPLAY DIGITALE**  
Il display digitale visualizza la pressione applicata durante la fase di utilizzo



DISPLAY DIGITALE

**FG 752/2P**

€/LISTINO  
~~4.400,00~~

**PROMO**  
**2.099,00€**

**SMONTA-AMMORTIZZATORI DOTATO DI 2 PISTONI E DISPLAY DIGITALE**  
Il display digitale visualizza la pressione applicata durante la fase di utilizzo



DISPLAY DIGITALE



# PRESSE IDRAULICHE

NEW



SCOPRI DI PIÙ



DOPPIA MODALITA' DI FUNZIONAMENTO:  
MANUALE CON LEVA E PNEUMATICA CON PEDALE

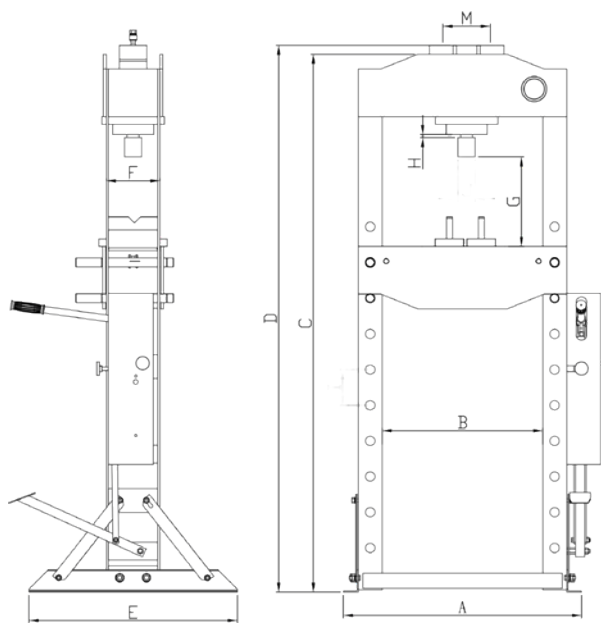

## MISURE (mm)

	A	B	C	D	E	F	G	H	M
FG 742/20TP	760	540	1612	1663	600	140	58-1018	145	180
FG 742/30TP	780	540	1808	1838	740	180	166-1126	150	200
FG 742/50TP	1030	730	1838	1918	740	202	88-1068	220	245

### FG 742/20TP

€/LISTINO  
~~2.100,00~~

PROMO  
**1.099,00**

#### PRESSA IDRAULICA MANUALE E PNEUMATICA CON PISTONE MOBILE

- Capacità 20 ton
- Funzionamento in 2 modalità: manuale con leva e pneumatica a pedale
- Pistone mobile con ritorno automatico
- Manometro
- Dotata di coppia di prismi a V
- Leva amovibile per funzionamento manuale
- Sistema pneumatico con funzionamento a pedale
- Altezza del piano di lavoro regolabile

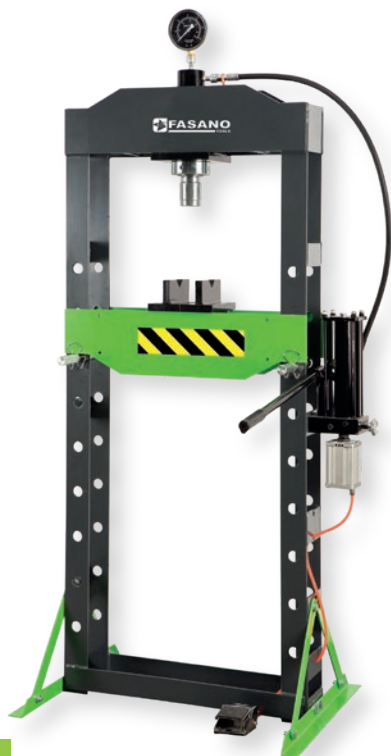

NEW



COPIA DI PRISMI A V



PISTONE MOBILE CON RITORNO AUTOMATICO

### FG 742/30TP

€/LISTINO  
~~2650,00~~

PROMO  
**1.399,00**

#### PRESSA IDRAULICA MANUALE E PNEUMATICA CON PISTONE MOBILE

- Capacità 30 ton
- Funzionamento in 2 modalità: manuale con leva e pneumatica a pedale
- Pistone mobile con ritorno automatico
- Manometro
- Dotata di coppia di prismi a V
- Leva amovibile per funzionamento manuale
- Sistema pneumatico con funzionamento a pedale
- Con argano a fune per la regolazione dell'altezza del piano di lavoro

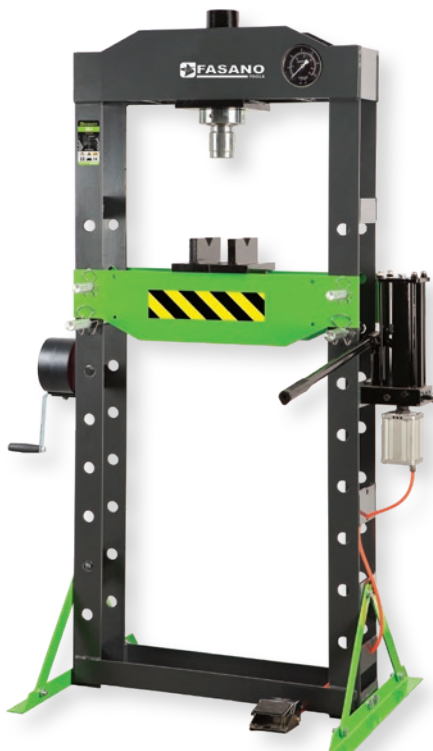

NEW



ARGANO A FUNE PER REGOLARE ALTEZZA PIANO DI LAVORO



PISTONE MOBILE CON RITORNO AUTOMATICO

**FG 742/50TP**

€/LISTINO  
~~4.800,00~~

**PROMO**  
**2.499,00**

**PRESSA IDRAULICA MANUALE E PNEUMATICA CON PISTONE MOBILE**

Capacità 50 ton  
Funzionamento in 2 modalità: manuale con leva e pneumatica a pedale  
Pistone mobile con ritorno automatico - Manometro  
Dotata di coppia di prismi a V  
Leva amovibile per funzionamento manuale  
Sistema pneumatico con funzionamento a pedale  
Con argano a fune per la regolazione dell'altezza del piano di lavoro



**NEW**



ARGANO A FUNE PER  
REGOLARE ALTEZZA PIANO  
DI LAVORO



PISTONE MOBILE CON  
RITORNO AUTOMATICO

**FG 745/CMR**

€/LISTINO  
~~950,00~~

**PROMO**  
**499,00€**

**CAVALLETTO SOSTEGNO MOTORE RICHIUDIBILE**

Versione richiudibile  
Possibilità di rotazione a 360°  
Ruote in acciaio per una maggiore durata e capacità  
L1/mm 995 - L2/mm 585



SISTEMA DI ROTAZIONE A  
360° A MANOVELLA



**FG 740/0.6T**

€/LISTINO  
~~600,00~~

**PROMO**  
**319,00€**

**SOLLEVATORE IDRAULICO DA FOSSA E SOTTOPONTE**

Sistema di sollevamento a pedale  
Dotato di 4 ruote girevoli  
Portata 600kg

**600** PORTATA  
kg **MASSIMA**

**NEW**



**FG 745/CMF**

€/LISTINO  
~~470,00~~

**PROMO**  
**249,00€**

**CAVALLETTO SOSTEGNO MOTORE**

Possibilità di rotazione a 360°  
Ruote in acciaio per una maggiore durata e capacità  
L1/mm 860 - L2/mm 725



SISTEMA DI ROTAZIONE A 360°





## FG 718/2.5T

€ LISTINO  
~~470,00~~

PROMO  
**249,00€**

### SOLLEVATORE IDRAULICO 2.5T MODELLO CORTO

- Robusta struttura in acciaio
- Velocità di discesa controllata
- Manico con gomma antiurto
- 4 ruote in nylon
- Valvola di spurgo dell'aria

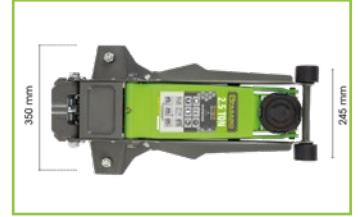

## FG 718/3.5T

€ LISTINO  
~~562,00~~

PROMO  
**299,00€**

### SOLLEVATORE IDRAULICO 3.5T MODELLO CORTO E RIBASSATO

- Design ribassato, ideale per lavorare su veicoli con bassa altezza da terra
- Portata elevata per utilizzo anche su fuoristrada e furgoni
- Robusta struttura in acciaio
- Velocità di discesa controllata
- Manico con gomma antiurto
- 4 ruote in nylon
- Valvola di spurgo dell'aria

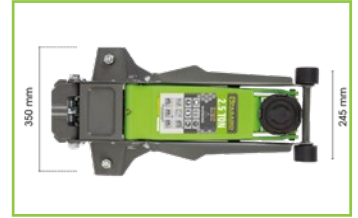

**FG 719/2T**

€/LISTINO  
~~740,00~~

**PROMO**  
**369,00€**

**SOLLEVATORE IDRAULICO 2T MODELLO LUNGO E RIBASSATO**

Design ribassato, ideale per lavorare anche su veicoli con bassa altezza da terra

Versione lunga

Sollevamento tramite manico con gomma antiurto

Robusta struttura in acciaio

Velocità di discesa controllata

4 ruote in nylon

Valvola di spurgo dell'aria



**FG 721/2T**

€/LISTINO  
~~910,00~~

**PROMO**  
**399,00€**

**SOLLEVATORE IDRAULICO 2T MODELLO LUNGO E RIBASSATO CON DOPPIE RUOTE ANTERIORI BASCULANTI**

Ideale per lavorare anche su veicoli con bassa altezza da terra

6 ruote in nylon (4 basculanti)

Sollevamento tramite manico rivestito con gomma antiurto

Robusta struttura in acciaio

Velocità di discesa controllata

Dotato di valvola di spurgo dell'aria



**FG 722/5T**

€/LISTINO  
~~1.440,00~~

**PROMO**  
**759,00€**

**SOLLEVATORE IDRAULICO A CARRELLO 5T MODELLO LUNGO PER MEZZI PESANTI**

Sistema di sollevamento ausiliario a pedale

Ruote in acciaio montate su cuscinetti a sfera

Self-return integrato

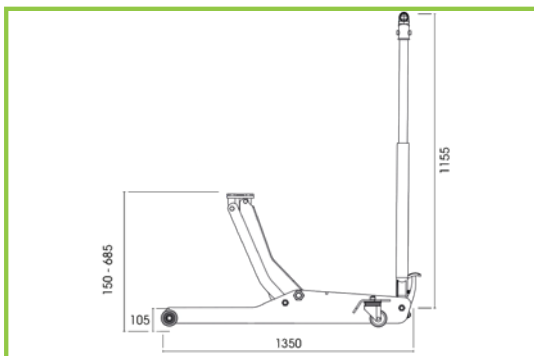

SISTEMA DI SOLLEVAMENTO AUSILIARIO A PEDALE



RUOTE IN ACCIAIO MONTATE SU CUSCINETTI A SFERA





## FG 213/LT

€/LISTINO  
~~330,00~~

PROMO  
**175,00€**

LEVA PER ESTRAZIONE TESTINE BRACCIO OSCILLANTE E AMMORTIZZATORI



## FG 213/SM

€/LISTINO  
~~820,00~~

PROMO  
**429,00€**

TRAVERSA SOSTEGNO MOTORE INFERIORE

Utile per il sostenimento del motore o del cambio durante i lavori di manutenzione sia di autovetture che di veicoli commerciali



ASTA ESTENDIBILE PER FACILITARE L'USO ANCHE SU VEICOLI CON COLLE DEL CAMBIO PARTICOLARMENTE LARGHE

COPPIA DI COLONNETTE DI SOSTEGNO



CODICE	CAPACITÀ KG	H-MIN/MAX MM	€/LISTINO	€/PROMO
FG 725/3T	3000	285-425	100,00	52,90€
FG 725/6T	6000	390-605	170,00	89,00€
FG 725/12T	12000	495-720	300,00	159,00€

SOLLEVATORI IDRAULICI A BOTTIGLIA



CODICE	CAPACITÀ KG	H-MIN/MAX MM	€/LISTINO	€/PROMO
FG 735/4T	4000	193-373	85,00	45,00€
FG 735/6T	6000	210-416	98,00	52,00€
FG 735/10T	10000	230-460	142,00	75,00€
FG 735/16T	16000	230-440	168,00	89,00€
FG 735/20T	20000	242-452	210,00	109,00€

## FG 750/A

€/LISTINO  
~~430,00~~

PROMO  
**229,00€**

CARRELO MOVIMENTAZIONE VEICOLI

Capacità 680 Kg  
L1/mm: 550 - L2/mm: 620  
Sistema di sollevamento a pedale  
Dotato di 4 ruote girevoli

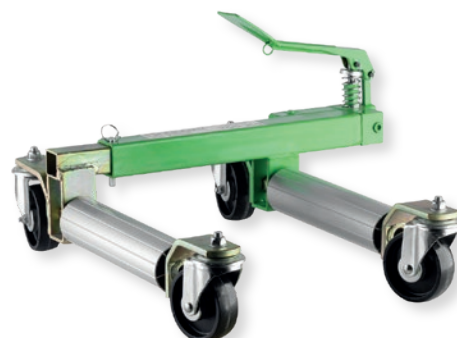

## FG 748/0.5T

€/LISTINO  
~~250,00~~

PROMO  
**132,00€**

SUPPORTO SOSTEGNO MOTORE

Capacità kg: 500  
L/mm: 1550



## FG 738/1T

€/LISTINO  
~~1.100,00~~

PROMO  
**579,00€**

GRU IDRAULICA PIEGHEVOLE

Versione richiudibile  
Ruote in acciaio per una maggiore durata e capacità  
Portata massima 1.000 kg  
L/mm: 800 - A/mm: 80



POMPA A DOPIO EFFETTO

**FG 1009/...**

**POLO IN COTONE**

Tessuto 96% cotone 4% elastan  
Peso 190 g/m2  
3 bottoni  
taglia M - L - XL



CODICE	€/LISTINO	€/PROMO
FG 1009/M	55,00€	32,90€
FG 1009/L	55,00€	32,90€
FG 1009/XL	55,00€	32,90€

**FG 1010/...**

**T-SHIRT IN COTONE**

Tessuto 100% cotone  
Peso 160 g/m2  
taglia M - L - XL



CODICE	€/LISTINO	€/PROMO
FG 1010/M	26,00€	15,90€
FG 1010/L	26,00€	15,90€
FG 1010/XL	26,00€	15,90€

**FG 1020/...**

**GILET IN TESSUTO TECNICO SOFTSHELL**

Comodo, traspirante e termoregolabile  
TESSUTO 100% poliestere  
Peso 320 g/m2  
Chiusura frontale  
2 tasche esterne con cerniera  
+ 2 tasche interne  
Inseri rifrangenti sui fianchi  
taglia M - L - XL



CODICE	€/LISTINO	€/PROMO
FG 1020/M	135,00€	79,00€
FG 1020/L	135,00€	79,00€
FG 1020/XL	135,00€	79,00€

**FG 1022/...**

**GIACCA IN TESSUTO TECNICO SOFTSHELL**

Comoda, traspirante e termoregolabile  
TESSUTO 100% poliestere - Peso 320 g/m2  
Chiusura frontale  
3 tasche esterne con cerniera  
+ 2 tasche interne  
Inseri rifrangenti sulle maniche  
taglia M - L - XL



CODICE	€/LISTINO	€/PROMO
FG 1022/M	165,00€	99,00€
FG 1022/L	165,00€	99,00€
FG 1022/XL	165,00€	99,00€

**FG 1015**

**CAPPELLINO CON VISIERA**

Tessuto 65% poliestere 35% cotone  
taglia unica



€/LISTINO	<del>13,00</del>	<b>PROMO</b>
		<b>7,90€</b>

**FG 1014**

**BERRETTO INVERNALE**

TESSUTO 100% acrilico  
Con risvolto  
taglia unica



€/LISTINO	<del>22,00</del>	<b>PROMO</b>
		<b>12,90€</b>

**FG 1016**

**CAPPELLINO A 6 PANNELLI CON VISIERA**

Tessuto 100% poliestere con lavorazione ottoman  
Chiusura regolabile con fibbia in metallo  
taglia unica



€/LISTINO	<del>30,00</del>	<b>PROMO</b>
		<b>17,90€</b>

**FG 1012**

**ZAINO IN TESSUTO TECNICO**

Ampio vano centrale con tasca porta pc  
Due tasche frontali con cerniera  
e due tasche laterali  
Schienale e spallacci imbottiti  
Dimensioni: 40x30x18 cm



€/LISTINO	<del>54,00</del>	<b>PROMO</b>
		<b>32,90€</b>

# INDICE ANALITICO

CODICE	PAGINA	€/Pz
FG 22/S6	12	21,90€
FG 22/S8B	12	31,90€
FG 22/S8	12	27,90€
FG 22/S12	12	53,90€
FG 22TX/S6	13	39,90€
FG 22RTX/S8	13	49,90€
FG 22FX/S10	13	89,90€
FG 22E/S6	16	36,90€
FG 22E/SZ6	16	36,90€
FG 30/GA1.5	5	24,00€
FG 30/GA2	5	29,00€
FG 30/GA2B	5	34,00€
FG 30/GA2.5	5	49,00€
FG 30/GA3	5	75,00€
FG 30/GA5	5	90,00€
FG 30/GA6	5	145,00€
FG 32/GP1	5	19,00€
FG 32/GP1.5	5	27,00€
FG 32/GP2	5	42,00€
FG 33/GA2	5	36,00€
FG 33/GA2.5	5	49,00€
FG 33/GA3	5	85,00€
FG 33/GA5	5	155,00€
FG 33/GA6	5	189,00€
FG 34/GL1	5	14,90€
FG 34/GL1.5	5	18,00€
FG 34/GL2	5	21,00€
FG 34/GL2.5	5	24,00€
FG 34/GL3	5	27,00€
FG 44/MT3	22	6,90€
FG 44/MT5	22	10,90€
FG 44/MT8	22	14,90€
FG 44/MT10	22	17,90€
FG 47/S3	23	36,90€
FG 48/B	21	13,90€
FG 48/C	21	5,90€
FG 48/P	21	8,90€
FG 49/L	21	10,90€
FG 49/MU	21	15,90€
FG 49/TC	21	26,90€
FG 49/CF	21	17,90€
FG 49/TCX	21	35,90€
FG 51/S4	15	56,90€
FG 51/S4B	15	62,90€
FG 55/S4	15	79,90€
FG 55/S4B	15	84,90€

CODICE	PAGINA	€/Pz
FG 58/C250	15	23,90€
FG 59XT/S3	15	49,90€
FG 59XT/S3B	15	59,90€
FG 59IS/S3	16	69,90€
FG 68/SP	16	21,90€
FG 68/SP2	16	11,90€
FG 68U/S439	16	179,00€
FG 70/S110	20	199,00€
FG 75CO/S25	20	149,00€
FG 77/PVC4	21	29,90€
FG 81HSS/S3	20	159,00€
FG 85/175-S9	15	59,90€
FG 85/175-S10	15	59,90€
FG 88/25-S31	14	59,00€
FG 92/PM	23	12,90€
FG 92/PM4	23	14,90€
FG 92/GR	23	16,90€
FG 92/PF	23	15,90€
FG 93/M50	23	18,90€
FG 93/M95	23	18,90€
FG 95/DG	22	57,90€
FG 95/CA	22	29,90€
FG 96/DG	17	119,00€
FG 96/SS36	24	39,90€
FG 97/DG	17	79,00€
FG 97/LT	118	149,00€
FG 98/DG	17	199,00€
FG 98/GAS	24	85,00€
FG 98/LT	24	115,00€
FG 98/B	118	349,00€
FG 98/C	118	699,00€
FG 98/A1.5	119	39,90€
FG 98/A5	119	69,90€
FG 98/A15	119	169,00€
FG 98/A25	119	199,00€
FG 98/A160	119	849,00€
FG 99/DG	17	149,00€
FG 100V/5T	56	519,00 €
FG 100B/5T	56	519,00 €
FG 100D/5T	56	519,00 €
FG 100R/5T	56	519,00 €
FG 100W/5T	56	519,00 €
FG 100V/6T	56	549,00 €
FG 100B/6T	56	549,00 €
FG 100D/6T	56	549,00 €
FG 100R/6T	56	549,00 €

CODICE	PAGINA	€/Pz
FG 100W/6T	56	549,00 €
FG 100V/7T	56	569,00 €
FG 100B/7T	56	569,00 €
FG 100D/7T	56	569,00 €
FG 100R/7T	56	569,00 €
FG 100W/7T	56	569,00 €
FG 122V/AS212	64	1.099,00€
FG 122B/AS212	64	1.099,00€
FG 122R/AS212	64	1.099,00€
FG 122D/AS212	64	1.099,00€
FG 100V/AS183	65	1.199,00€
FG 100B/AS183	65	1.199,00€
FG 100R/AS183	65	1.199,00€
FG 100D/AS183	65	1.199,00€
FG 100W/AS183	65	1.199,00€
FG 100V/AS371	66	1.399,00€
FG 100B/AS371	66	1.399,00€
FG 100R/AS371	66	1.399,00€
FG 100D/AS371	66	1.399,00€
FG 100W/AS371	66	1.399,00€
FG 100V/AS224	73	1.199,00€
FG 100B/AS224	73	1.199,00€
FG 100R/AS224	73	1.199,00€
FG 100D/AS224	73	1.199,00€
FG 100W/AS224	73	1.199,00€
FG 122V/AS413	74	1.399,00€
FG 122B/AS413	74	1.399,00€
FG 122R/AS413	74	1.399,00€
FG 122D/AS413	74	1.399,00€
FG 100V/AS230	75	1.399,00€
FG 100B/AS230	75	1.399,00€
FG 100R/AS230	75	1.399,00€
FG 100D/AS230	75	1.399,00€
FG 100W/AS230	75	1.399,00€
FG 100VD/AS355	77	1.599,00€
FG 100VW/AS355	77	1.599,00€
FG 100BW/AS355	77	1.599,00€
FG 100BD/AS355	77	1.599,00€
FG 100RD/AS355	77	1.599,00€
FG 100RY/AS355	77	1.599,00€
FG 100CW/AS355	77	1.599,00€
FG 100MA/AS355	77	1.599,00€
FG 100RW/AS355	77	1.599,00€
FG 100RB/AS355	77	1.599,00€
FG 100DP/AS355	77	1.599,00€
FG 100DW/AS355	77	1.599,00€

CODICE	PAGINA	€/Pz
FG 100BY/AS355	77	1.599,00€
FG 100GW/AS355	77	1.599,00€
FG 100V/AS56	131	1.299,00€
FG 100B/AS56	131	1.299,00€
FG 100R/AS56	131	1.299,00€
FG 100D/AS56	131	1.299,00€
FG 100W/AS56	131	1.299,00€
FG 100/03G	80	95,00€
FG 100/03G-A	80	99,90€
FG 100/03L	80	95,00€
FG 100/03L-A	80	99,90€
FG 100/03H	80	189,00€
FG 100/03H-A	80	195,00€
FG 100/03E	80	59,90€
FG 100/03F	80	64,90€
FG 100/07C	80	65,90€
FG 100/07D	80	97,90€
FG 100/08C	80	149,00€
FG 100/10C	80	239,00€
FG 100/10D	81	349,00€
FG 100/17	81	85,00€
FG 100/17E	81	175,00€
FG 100/18	81	179,00€
FG 100/19	81	145,00€
FG 100/21B	81	149,00€
FG 100/21C	81	149,00€
FG 100/21M	81	99,00€
FG 100/21D	81	99,00€
FG 100/21H	81	269,00€
FG 100/21TX	81	159,00€
FG 100/81F	81	119,00€
FG 100/23C	82	135,00€
FG 100/23B	82	219,00€
FG 100/39XT	82	66,90€
FG 100/41C	82	67,90€
FG 100/42C	82	71,90€
FG 100/65B	82	54,90€
FG 100/65C	82	82,90€
FG 100/45D	82	41,90€
FG 100/45E	82	49,90€
FG 100/45F	82	42,90€
FG 100/45G	82	42,90€
FG 100/45I	83	51,90€
FG 100/45T	83	52,90€
FG 100/45H	83	49,00€
FG 100/48G	83	79,90€

CODICE	PAGINA	€/Pz
FG 100/51H	83	89,00€
FG 100/50F	83	54,90€
FG 100/50G	83	54,90€
FG 100/56C	83	82,90€
FG 100/54	83	109,00€
FG 100/76C	83	169,00€
FG 100/03M	84	279,00€
FG 100/21F	86	599,00€
FG 100/81G	86	499,00€
FG 100/39E	85	259,00€
FG 100/39F	85	249,00€
FG 100/45R	84	159,00€
FG 100/56D	87	219,00€
FG 100/95B	87	399,00€
FG 100/95C	87	469,00€
FG 100/PR	54	37,90€
FG 101V/3G	59	249,00€
FG 101D/AS165	60	699,00€
FG 101D/AS196	61	799,00€
FG 102/03G	68	85,00€
FG 102/03L	68	89,00€
FG 102/03H	68	149,00€
FG 102/03E	68	51,90€
FG 102/03F	68	59,90€
FG 102/07C	68	59,90€
FG 102/07D	68	83,90€
FG 102/08C	68	149,00€
FG 102/10C	68	209,00€
FG 102/13C	68	115,00€
FG 102/17	69	79,90€
FG 102/17E	69	169,00€
FG 102/19	69	119,00€
FG 102/19B	69	119,00€
FG 102/21B	69	149,00€
FG 102/21C	69	149,00€
FG 102/21E	69	99,00€
FG 102/21D	69	99,00€
FG 102/21TX	70	149,00€
FG 102/21H	69	129,00€
FG 102/21R	69	139,00€
FG 102/25	69	239,00€
FG 102/25B	69	239,00€
FG 102/23C	70	89,00€
FG 102/51H	70	79,90€
FG 102/39XT	70	59,90€
FG 102/39D	70	45,90€

CODICE	PAGINA	€/Pz
FG 102/41C	70	59,90€
FG 102/42C	70	65,00€
FG 102/45D	70	28,90€
FG 102/45E	70	34,90€
FG 102/45F	70	32,90€
FG 102/45G	70	32,90€
FG 102/45U	70	59,90€
FG 102/45I	71	39,90€
FG 102/45L	71	39,90€
FG 102/45T	71	45,90€
FG 102/48G	71	72,90€
FG 102/50F	71	45,90€
FG 102/50G	71	45,90€
FG 102/56C	71	76,90€
FG 102/60D	71	29,90€
FG 102/62B	71	57,90€
FG 102/65B	71	39,90€
FG 102/VA1	71	8,90€
FG 102V/AS205	62	999,00€
FG 102B/AS205	62	999,00€
FG 102R/AS205	62	999,00€
FG 102D/AS205	62	999,00€
FG 104V/AS284	129	1.599,00€
FG 104D/AS284	129	1.599,00€
FG 104B/AS284	129	1.599,00€
FG 104R/AS284	129	1.599,00€
FG 106/B	91	179,00 €
FG 106/C	91	199,00 €
FG 107/A	91	79,00 €
FG BEST 108	8	139,00 €
FG 108/B	59	69,00 €
FG 109/L3	27	139,00 €
FG 111/AS104	25	329,00 €
FG 111/A	25	32,90 €
FG 111/B	25	39,90 €
FG 111/C	25	49,90 €
FG 113/A	25	119,00€
FG 113/B	25	129,00€
FG 113/C	25	149,00€
FG 113/D	25	199,00€
FG 117/PVC-1	95	12,90€
FG 117/PVC-2	95	4,90€
FG 117/PVC-3	95	2,90€
FG 117PVC/S5	95	129,00€
FG 117PVC/S6	95	149,00€
FG 117/CO2V	99	1.799,00€

CODICE	PAGINA	€/Pz
FG 117/CO2D	99	1.799,00€
FG 117/CO2B	99	1.799,00€
FG 117/CO2R	99	1.799,00€
FG 117/CO2V-60	99	1.999,00€
FG 117/CO2B-60	99	1.999,00€
FG 117/CO2D-60	99	1.999,00€
FG 117/CO2R-60	99	1.999,00€
FG 117/CO3V	99	2.199,00€
FG 117/CO3D	99	2.199,00€
FG 117/CO3B	99	2.199,00€
FG 117/CO3R	99	2.199,00€
FG 117/CO3V-60	99	2.399,00€
FG 117/CO3B-60	99	2.399,00€
FG 117/CO3D-60	99	2.399,00€
FG 117/CO3R-60	99	2.399,00€
FG 117/CO25V	100	2.349,00€
FG 117/CO25D	100	2.349,00€
FG 117/CO25B	100	2.349,00€
FG 117/CO25R	100	2.349,00€
FG 117/CO25V-60	100	2.549,00€
FG 117/CO25B-60	100	2.549,00€
FG 117/CO25D-60	100	2.549,00€
FG 117/CO25R-60	100	2.549,00€
FG 117/CO24D	100	2.499,00€
FG 117/CO24V	100	2.499,00€
FG 117/CO24B	100	2.499,00€
FG 117/CO24R	100	2.499,00€
FG 117/CO24V-60	100	2.699,00€
FG 117/CO24B-60	100	2.699,00€
FG 117/CO24D-60	100	2.699,00€
FG 117/CO24R-60	100	2.699,00€
FG 117/CO26D	104	2.699,00€
FG 117/CO26V	104	2.699,00€
FG 117/CO26B	104	2.699,00€
FG 117/CO26R	104	2.699,00€
FG 117/CO26V-60	104	2.899,00€
FG 117/CO26B-60	104	2.899,00€
FG 117/CO26D-60	104	2.899,00€
FG 117/CO26R-60	104	2.899,00€
FG 117D/AS266	102	2.999,00€
FG 117V/AS266	102	2.999,00€
FG 117B/AS266	102	2.999,00€
FG 117R/AS266	102	2.999,00€
FG 117D/AS266-60	102	3.199,00€
FG 117R/AS266-60	102	3.199,00€
FG 117B/AS266-60	102	3.199,00€

CODICE	PAGINA	€/Pz
FG 117V/AS266-60	102	3.199,00€
FG 117/CO16V	101	1.699,00€
FG 117/CO16D	101	1.699,00€
FG 117/CO16B	101	1.699,00€
FG 117/CO16R	101	1.699,00€
FG 117/CO16V-60	101	1.859,00€
FG 117/CO16B-60	101	1.859,00€
FG 117/CO16D-60	101	1.859,00€
FG 117/CO16R-60	101	1.859,00€
FG 117/CO30V	101	3.499,00€
FG 117/CO30D	101	3.499,00€
FG 117/CO30B	101	3.499,00€
FG 117/CO30R	101	3.499,00€
FG 117/CO30V-60	101	3.899,00€
FG 117/CO30B-60	101	3.899,00€
FG 117/CO30D-60	101	3.899,00€
FG 117/CO30R-60	101	3.899,00€
FG 117V/68LVA	105	799,00€
FG 117D/68LVA	105	799,00€
FG 117R/68LVA	105	799,00€
FG 117B/68LVA	105	799,00€
FG 117V/68LVA-60	105	849,00€
FG 117D/68LVA-60	105	849,00€
FG 117R/68LVA-60	105	849,00€
FG 117B/68LVA-60	105	849,00€
FG 117V/68LVB	105	599,00€
FG 117D/68LVB	105	599,00€
FG 117R/68LVB	105	599,00€
FG 117B/68LVB	105	599,00€
FG 117V/68LVB-60	105	649,00€
FG 117D/68LVB-60	105	649,00€
FG 117R/68LVB-60	105	649,00€
FG 117B/68LVB-60	105	649,00€
FG 118/CO2V	93	2.499,00€
FG 118/CO2D	93	2.499,00€
FG 118/CO2B	93	2.499,00€
FG 118/CO2R	93	2.499,00€
FG 118/CO3V	93	2.899,00€
FG 118/CO3D	93	2.899,00€
FG 118/CO3B	93	2.899,00€
FG 118/CO3R	93	2.899,00€
FG 118/CO30V	94	3.299,00€
FG 118/CO30D	94	3.299,00€
FG 118/CO30B	94	3.299,00€
FG 118/CO30R	94	3.299,00€
FG 118V/AS351	96	4.699,00€

# INDICE ANALITICO

CODICE	PAGINA	€/Pz
FG 118D/AS351	96	4.699,00€
FG 118B/AS351	96	4.699,00€
FG 118R/AS351	96	4.699,00€
FG 119V/CO16	106	899,00€
FG 119B/CO16	106	899,00€
FG 119R/CO16	106	899,00€
FG 119V/CO12	107	1.199,00€
FG 119B/CO12	107	1.199,00€
FG 119R/CO12	107	1.199,00€
FG 119V/CO25	107	989,00€
FG 119B/CO25	107	989,00€
FG 119R/CO25	107	989,00€
FG 119V/CO33	108	1.599,00€
FG 119B/CO33	108	1.599,00€
FG 119R/CO33	108	1.599,00€
FG 119V/CO18	108	999,00€
FG 119B/CO18	108	999,00€
FG 119R/CO18	108	999,00€
FG 119V/CO27	109	1.099,00€
FG 119B/CO27	109	1.099,00€
FG 119R/CO27	109	1.099,00€
FG 119M/CO13	109	599,00€
FG 119M/CO28	109	699,00€
FG 120/CO1V	58	1.199,00€
FG 120/CO1D	58	1.199,00€
FG 120/CO1B	58	1.199,00€
FG 120/CO1R	58	1.199,00€
FG 120/CO2V	58	1.249,00€
FG 120/CO2D	58	1.249,00€
FG 120/CO2B	58	1.249,00€
FG 120/CO2R	58	1.249,00€
FG 122V/5G	54	499,00€
FG 122B/5G	54	499,00€
FG 122D/5G	54	499,00€
FG 122R/5G	54	499,00€
FG 122V/6G	54	529,00€
FG 122B/6G	54	529,00€
FG 122D/6G	54	529,00€
FG 122R/6G	54	529,00€
FG 122V/7G	54	549,00€
FG 122B/7G	54	549,00€
FG 122D/7G	54	549,00€
FG 122R/7G	54	549,00€
FG 122V/AS217	72	1.099,00€
FG 122B/AS217	72	1.099,00€
FG 122D/AS217	72	1.099,00€

CODICE	PAGINA	€/Pz
FG 122R/AS217	72	1.099,00€
FG 122V/AS170	63	1.099,00€
FG 122B/AS170	63	1.099,00€
FG 122R/AS170	63	1.099,00€
FG 122D/AS170	63	1.099,00€
FG 122V/AS402	76	1.499,00€
FG 122D/AS402	76	1.499,00€
FG 122B/AS402	76	1.499,00€
FG 122R/AS402	76	1.499,00€
FG 122/PC	54	49,00€
FG 122/PL	54	34,90€
FG 123V/5G	56	699,00€
FG 123B/5G	56	699,00€
FG 123D/5G	56	699,00€
FG 123R/5G	56	699,00€
FG 123V/6G	56	729,00€
FG 123B/6G	56	729,00€
FG 123D/6G	56	729,00€
FG 123R/6G	56	729,00€
FG 123V/7G	56	749,00€
FG 123B/7G	56	749,00€
FG 123D/7G	56	749,00€
FG 123R/7G	56	749,00€
FG 124V/6G	55	619,00 €
FG 124B/6G	55	619,00 €
FG 124D/6G	55	619,00 €
FG 124R/6G	55	619,00 €
FG 124V/7G	55	659,00 €
FG 124B/7G	55	659,00 €
FG 124D/7G	55	659,00 €
FG 124R/7G	55	659,00 €
FG 124D/AS257	67	1.499,00€
FG 124V/AS257	67	1.499,00€
FG 124B/AS257	67	1.499,00€
FG 124R/AS257	67	1.499,00€
FG 124V/AS322	78	1.599,00€
FG 124D/AS322	78	1.599,00€
FG 124B/AS322	78	1.599,00€
FG 124R/AS322	78	1.599,00€
FG 125/S3	23	39,90€
FG 125V/5G	55	729,00€
FG 125B/5G	55	729,00€
FG 125D/5G	55	729,00€
FG 125R/5G	55	729,00€
FG 125V/6G	55	749,00€
FG 125B/6G	55	749,00€

CODICE	PAGINA	€/Pz
FG 125D/6G	55	749,00€
FG 125R/6G	55	749,00€
FG 125V/7G	55	769,00 €
FG 125B/7G	55	769,00 €
FG 125D/7G	55	769,00 €
FG 125R/7G	55	769,00 €
FG 125/LV	116	11,90€
FG 125/SB	117	39,00€
FG 126/S3	23	19,90€
FG 126V/6G	55	849,00 €
FG 126B/6G	55	849,00 €
FG 126D/6G	55	849,00 €
FG 126R/6G	55	849,00 €
FG 126V/7G	55	899,00 €
FG 126B/7G	55	899,00 €
FG 126D/7G	55	899,00 €
FG 126R/7G	55	899,00 €
FG 127V/A	59	299,00 €
FG 127V/B	59	359,00 €
FG 128/S11	22	72,90€
FG 128C/S6	22	28,90€
FG 128/2	88	349,00 €
FG 128/D2	88	479,00 €
FG 128/B2	88	479,00 €
FG 128/R2	88	479,00 €
FG 129/2	88	449,00 €
FG 129/D2	88	579,00 €
FG 129/B2	88	579,00 €
FG 129/R2	88	579,00 €
FG 129/1	89	289,00 €
FG 129/D1	89	359,00 €
FG 129/B1	89	359,00 €
FG 129/R1	89	359,00 €
FG 129/1.5	89	339,00 €
FG 129/D1.5	89	419,00 €
FG 129/B1.5	89	419,00 €
FG 129/R1.5	89	419,00 €
FG 130AL/S5	124	22,90€
FG 130/S10	124	399,00€
FG 131/D2	90	899,00€
FG 131/B2	90	899,00€
FG 131/R2	90	899,00€
FG 132/D2	90	1.249,00€
FG 132/B2	90	1.249,00€
FG 132/R2	90	1.249,00€
FG 137/D1.5	90	739,00€

CODICE	PAGINA	€/Pz
FG 137/B1.5	90	739,00€
FG 137/R1.5	90	739,00€
FG 138/BP	14	36,90€
FG 138/M	14	37,90€
FG 138	14	32,90€
FG 138/B	14	19,90€
FG 138/C	14	19,90€
FG 139/B	13	9,90€
FG 139/C	13	14,90€
FG 139/LM	13	33,90€
FG 139	13	22,90€
FG 139/L	13	24,90€
FG 142/S9	13	76,90€
FG 143TX/S6	14	49,90€
FG 150TX/S32	9	119,00€
FG 150M/S26	10	99,00€
FG 150H/S30	10	99,00€
FG 152/RTXS10	11	99,00€
FG 152RH/S9	11	69,00€
FG 152RM/S9	11	69,00€
FG 159/PM	117	139,00€
FG 162/S3	42	219,00€
FG 162V/14P	57	1.699,00€
FG 162B/14P	57	1.699,00€
FG 162D/14P	57	1.699,00€
FG 162R/14P	57	1.699,00€
FG 162B/14L	57	1.699,00€
FG 162D/14L	57	1.699,00€
FG 162R/14L	57	1.699,00€
FG 162V/14L	57	1.699,00€
FG 162V/AS308	79	2.799,00€
FG 162B/AS308	79	2.799,00€
FG 162R/AS308	79	2.799,00€
FG 162D/AS308	79	2.799,00€
FG 163/S2B	42	159,00€
FG 165/IE1	42	199,00€
FG 165/IE2	42	459,00€
FG 165/MB1	43	99,00€
FG 165/MB2	43	199,00€
FG 165/S26	117	429,00€
FG 165BC/S6	128	139,00€
FG 166/S28	117	279,00€
FG 166/DS19	128	39,90€
FG 166/DS24	128	39,90€
FG 168/EF1	42	209,00€
FG 168/EF2	42	215,00€

CODICE	PAGINA	€/Pz
FG 168SD/S4	43	99,00€
FG 168A/S5	43	69,00€
FG 168A/S13	43	129,00€
FG 168EP/S5	43	21,00€
FG 168/S25	43	89,00€
FG 168/S9	43	109,00€
FG 168/GA	117	38,90€
<b>FG BEST 171</b>	<b>8</b>	<b>179,00€</b>
FG 171/FL	123	29,90€
FG 171/N	123	17,90€
FG 172/BS	112	129,00€
FG 172/FA	122	41,90€
FG 172/PA	122	43,90€
FG 172/MA	122	59,90€
FG 172/AS2	122	69,00€
FG 172/TC	122	19,90€
FG 172/TG	122	21,90€
FG 172/RL2	123	14,90€
FG 172/G02	123	63,90€
FG 172/OT	123	33,90€
FG 172/CA	123	35,90€
FG 174/SC	114	72,90€
FG 175/S30	110	129,00€
FG 175/PR	110	23,90€
FG 175PF/S4	110	45,90€
FG 175/S114	111	129,00€
FG 175/S15	111	79,90€
FG 175/S4	111	39,90€
FG 176/S13	112	269,00€
FG 178/UF	110	35,90€
FG 178/UF83	111	19,90€
FG 178/FL	111	26,90€
FG 178/UF110	111	69,00€
FG 178/UF145	111	99,00€
FG 178/BF	115	149,00€
FG 178/S6	115	189,00€
<b>FG 179/SF</b>	<b>115</b>	<b>929,00€</b>
FG 179/ST	122	14,90€
FG 180/SP9	3	129,00€
FG 181RE/S2	114	49,90€
FG 181/C14	114	19,90€
FG 181/PM2	122	54,90€
FG 182/S5B	43	289,00€
FG 182/S14	43	149,00€
FG 182/S16	114	309,00€
FG 182/RG10	126	12,90€

CODICE	PAGINA	€/Pz
FG 182/RG24	126	16,90€
FG 183/S5	114	69,00€
FG 183/RV1	126	12,90€
FG 183/CM	127	29,90€
FG 183/CK250	127	12,90€
FG 183/CK450	127	19,90€
FG 183/CK600	127	24,90€
FG 183/RA1	1237	15,90€
FG 184/S5	119	99,00€
FG 184/S4	123	59,90€
FG 184P/S3	124	15,90€
FG 184R/S3	125	28,90€
FG 184/R1	125	12,90€
FG 184/R2	125	13,90€
FG 185P/S4	120	17,90€
FG 185B/S2	125	25,90€
FG 185/S5	125	59,90€
FG 185/CR	126	6,90€
FG 185/OM	126	18,90€
FG 185/RM	126	19,90€
FG 186P/S4	116	14,90€
FG 186P/S5	125	19,90€
FG 186/S5	125	59,90€
FG 186/AL1	125	15,90€
FG 186/S4	125	16,90€
FG 186/S3	126	5,90€
FG 186/S3B	126	6,90€
FG 187/GU	127	17,90€
FG 187/S7	127	129,00€
FG 187/GR	127	18,90€
FG 187/GU2	127	17,90€
FG 187/K40	127	119,00€
FG 187/S2	128	459,00€
FG 187/PN	128	159,00€
FG 188/P1	124	12,90€
FG 188P/S2	124	25,90€
FG 188P/S4	128	39,90€
FG 189/PO1	126	13,90€
FG 189/PO2	126	24,90€
FG 190/RI	113	34,90€
FG 190/IP	113	28,90€
FG 190/OP	113	26,90€
FG 190/RE	113	99,00€
FG 190/S8	113	49,00€
FG 190/S6B	114	99,00€
FG 191/S22	113	369,00€

CODICE	PAGINA	€/Pz
FG 191/S24	113	279,00€
FG 191/S14	114	95,00€
FG 198/PE	116	35,90€
FG 198/S11	117	82,90€
FG 198/S7	117	49,90€
FG 198/DF	117	219,00€
FG 199/PF	116	139,00€
FG 201	30	29,90€
FG 201/S7	112	199,00€
FG 202	28	33,90€
FG 202/PV	111	139,00€
FG 203	28	9,90€
FG 203/S20	112	219,00€
FG 203/BW1	112	22,90€
FG 203/FO1	112	22,90€
FG 203/FO2	112	22,90€
FG 203/FT1	112	27,90€
FG 203/OP1	112	22,90€
FG 203/TO1	112	22,90€
FG 203/S7	112	99,00€
FG 204	28	19,90€
FG 205/C	31	69,00€
FG 205/B	31	49,90€
FG 206	30	33,90€
FG 207	29	38,90€
FG 207/B	29	59,90€
FG 209	33	149,00€
FG 210/C	32	99,00€
FG 210/W	32	39,90€
FG 210/B	33	39,90€
FG 211	29	59,90€
FG 212	29	43,90€
FG 213/B	30	79,00€
FG 213/L480	30	39,90€
<b>FG 213/LT</b>	<b>138</b>	<b>175,00€</b>
<b>FG 213/SM</b>	<b>138</b>	<b>429,00€</b>
FG 214/L600	28	42,90€
FG 215/S40	120	879,00€
FG 217/B	31	179,00€
FG 219/S	120	1.999,00€
FG 220/BT	121	249,00€
FG 220/EN	121	259,00€
FG 221	32	159,00€
FG 222/A	32	49,00€
FG 222/B	32	169,00€
FG 224/SU	33	49,00€

CODICE	PAGINA	€/Pz
FG 224/L5200	33	129,00€
<b>FG 225/SK1.5</b>	<b>35</b>	<b>149,00€</b>
<b>FG 225/SK2.5</b>	<b>35</b>	<b>179,00€</b>
FG 234	34	59,00€
FG 235	34	79,00€
FG 236	35	199,00€
FG 236/SU	35	59,00€
FGA 290	46	119,00€
FGA 291/D	46	109,00€
FGA 292/B	46	129,00€
<b>FG 305/LT2</b>	<b>38</b>	<b>399,00€</b>
FGA 307	44	149,00€
FGA 307/AN	44	189,00€
FGA 309	44	179,00€
<b>FG 310/LT2</b>	<b>38</b>	<b>469,00€</b>
FGA 312	44	199,00€
<b>FG 315/LT2</b>	<b>38</b>	<b>529,00€</b>
FGA 316	45	459,00€
FGA 316/L	45	519,00€
<b>FGA 319</b>	<b>45</b>	<b>659,00€</b>
<b>FGA 319/L</b>	<b>45</b>	<b>719,00€</b>
<b>FG 320/LT2</b>	<b>39</b>	<b>569,00€</b>
<b>FGA 321</b>	<b>45</b>	<b>589,00€</b>
<b>FGA 321/B</b>	<b>45</b>	<b>649,00€</b>
<b>FGA 321/C</b>	<b>45</b>	<b>699,00€</b>
FGA 322	46	85,00€
<b>FG 325/LT2</b>	<b>39</b>	<b>349,00€</b>
<b>FG 330/LT2</b>	<b>37</b>	<b>399,00€</b>
FGA 330	49	179,00€
FGA 332	49	89,00€
FGA 334	50	89,00€
FGA 334/AN115	50	109,00€
FGA 334/AN	50	109,00€
FGA 334/L	50	109,00€
<b>FG 335/LT2</b>	<b>37</b>	<b>439,00€</b>
FGA 335	49	119,00€
FGA 336	49	369,00€
FGA 337	49	79,00€
FGA 338	50	75,00€
FGA 338/AN	50	99,00€
FGA 338/L	50	99,00€
FGA 339	49	199,00€
FGA 340	48	169,00€
FGA 340/B	48	169,00€
FGA 342/B	48	169,00€
FGA 342	48	139,00€

# INDICE ANALITICO

CODICE	PAGINA	€/Pz
FGA 343/N10	48	139,00€
FGA 343/N20	48	189,00€
FGA 344	48	149,00€
FGA 346/B	50	139,00€
FGA 348/A	51	99,00€
FGA 348/B	51	119,00€
FGA 348/C	51	149,00€
FGA 348/D	51	159,00€
FG 360/LT1	40	259,00€
FG 363/LT1	40	269,00€
FG 366/LT1	40	279,00€
FG 370/LT1	41	319,00€
FG 373/LT1	41	319,00€
FG 380/LT1	41	269,00€
FG 383/LT1	41	279,00€
FGA 383/AR15	47	139,00€
FGA 385/AR15	47	179,00€
FGA 390	46	99,00€
FGA 416	47	12,90€
FGA 419	47	13,90€
FG 491/200	112	22,90€
FG 491/1500	112	51,90€
FG 491/DF1500	112	79,90€
FG 493/AL	24	28,90€
FG 493/N	24	23,90€
FG 494/S12	24	32,90€
FG 494/A180	24	99,00€
FG 531	18	129,00€
FG 533/2	18	145,00€
FG 536/1	18	145,00€
FG 536/2	18	149,00€
FG 536/3	18	169,00€
FG 538/1	18	489,00€
FG 538/2	18	539,00€
FG 539/1	18	699,00€
FG 540/1	18	639,00€
FG 540/2	18	729,00€
FG 540/3	18	849,00€
FG 543/DG1	19	399,00€
FG 543/DG2	19	469,00€
FG 544/1	19	119,00€
FG 544/2	19	129,00€
FG 544/3	19	139,00€
FG 544/4	19	169,00€
FG 546/DG	19	199,00€
FG 547/DG	19	129,00€

CODICE	PAGINA	€/Pz
FG 581/A	19	529,00€
FG 581/B	19	799,00€
FG 600/SC16	2	139,00€
FG 600/SC25	2	219,00€
FG 600A/SC16	2	149,00€
FG 600A/SC25	2	229,00€
FG 600L/SC10	2	99,00€
FG 600XL/SC7	3	129,00€
FG 600TW/S12	3	119,00€
FG 600E/S4	3	33,90€
FG 602/SC13	3	89,00€
FG 603/S28A	130	559,00€
FG 603/S28B	130	559,00€
FG 603/TA1	131	149,00€
FG 605/ST11-B	5	139,00€
FG 606/SP9	5	85,00€
FG 610FL/SP9	5	149,00€
FG 615/SC8	3	69,00€
FG 615A/S6	5	79,00€
FG 618/S7B	4	159,00€
FG 618/S7	4	175,00€
FG 618/S10	4	249,00€
FG 621H/S8C	4	99,00€
FG 621TX/S13	4	149,00€
FG 622A/S2	5	49,00€
FG 623H/S6	4	72,00€
FG 623H/S8	4	105,00€
FG 623H/S14	4	209,00€
FG 624/S25	6	49,00€
FG 625/S15	6	59,00€
FG 625/S110	7	259,00€
FG 625/S27	7	99,00€
FG 625TX/S77	9	179,00€
FG 628/S6	11	59,00€
FG 628/S12	11	79,00€
FG 628/S7	116	69,00€
FG 628/R17.5	116	12,90 €
FG 628/R18.5	116	12,90 €
FG 628/R21.5	116	13,90 €
FG 628/R22.5	116	13,90 €
FG 628/R27.5	116	15,90 €
FG 629A/S15	10	339,00€
FG 629B/S15	10	339,00€
FG 629C/S10	11	179,00€
FG 630A/S14	11	499,00€
FG 718/2.5T	136	249,00 €

CODICE	PAGINA	€/Pz
FG 718/3.5T	136	299,00 €
FG 719/2T	137	369,00 €
FG 721/2T	137	399,00 €
FG 722/5T	137	759,00 €
FG 725/3T	138	52,90 €
FG 725/6T	138	89,00 €
FG 725/12T	138	159,00 €
FG 735/4T	138	45,00 €
FG 735/6T	138	52,00 €
FG 735/10T	138	75,00 €
FG 735/16T	138	89,00 €
FG 735/20T	138	109,00 €
FG 738/1T	138	579,00 €
FG 740/0.6T	137	319,00 €
FG 742/20TP	134	1.099,00 €
FG 742/30TP	134	1.399,00 €
FG 742/50TP	135	2.499,00 €
FG 745/CMR	135	499,00 €
FG 745/CMF	135	249,00 €
FG 748/0.5T	138	132,00 €
FG 750/A	138	229,00 €
FG 750/1P	133	1.599,00 €
FG 750/2P	133	1.899,00 €
FG 752/1P	133	1.799,00 €
FG 752/2P	133	2.099,00 €
FG 1425	27	59,90€
FG 1426	27	72,90€
FG 1427	27	99,00€
FG 1433	27	99,00€
FG 1434	27	89,00€
FG 1440	27	29,90€
FG 1445	27	24,90€
FG 1450	26	79,90€
FG 1452	26	85,90€
FG 1454	26	109,00€
FG 1456	26	139,00€
FG 1460	26	89,00€
FG 1465	26	119,00€
FG 1009/M	139	32,90€
FG 1009/L	139	32,90€
FG 1009/XL	139	32,90€
FG 1010/M	139	15,90€
FG 1010/L	139	15,90€
FG 1010/XL	139	15,90€
FG 1020/M	139	79,00€
FG 1020/L	139	79,00€

CODICE	PAGINA	€/Pz
FG 1020/XL	139	79,00€
FG 1022/M	139	99,00€
FG 1022/L	139	99,00€
FG 1022/XL	139	99,00€
FG 1015	139	7,90€
FG 1016	139	17,90€
FG 1014	139	12,90€
FG 1012	139	32,90€

**DISTRIBUTORE UFFICIALE**

**FASANGAS S.r.l.**

**SEDE LEGALE E LOGISTICA**

Viale Grecia 3, lotto 18  
- 73100 Zona Ind.le LECCE - ITALY

**SEDE PRODUTTIVA**

Viale Irlanda 3 - 73100  
Zona Ind.le LECCE - ITALY  
(+39) 0832.362097/364265

info@fasanotools.com



8 054341 830781

**VALIDITA':**  
**02-02-2026 / 31-01-2027**

**FASANOTOOLS.COM**



**FASANO**  
TOOLS

